

Instruction Manual

Thank you for purchasing this product.
Before using this product, please read the instructions carefully.
After reading the instruction manual, please keep it for reference.

Caution



Caution

**Parents/Guardians:
Please read the following information carefully.**

- This product contains small parts. Keep away from children under 3 years old.
- Keep this product away from small children or infants.
Seek medical attention immediately if any small parts are swallowed.
- Long cord. Strangulation hazard.
- Keep the product away from dusty or humid areas.
- Do not use this product if it has been damaged or modified.
- Do not get this product wet. This may cause an electric shock or malfunction.
- Do not place this product near heat sources or leave under direct sunlight for an extended period. Overheating may cause malfunction.
- Do not touch the metal parts of the USB plug.
- Do not apply strong impact or weight on the product.
- Do not pull roughly or bend the cable of the product.
- If product needs cleaning, use only a soft dry cloth.
Do not use any chemical agents like benzene or thinner.
- Do not use this product for anything other than its intended purpose.
We are not responsible for any accidents or damages in the event of use other than the intended purpose.



Since this product is heavy, it may cause injury if dropped.



Parental supervision is suggested when the product is being used by children.
Please keep away from children under 3 years old.

How to Connect

① Open the housing cover and remove the USB cable.

- 1) Open up the housing cover by sliding the latch.

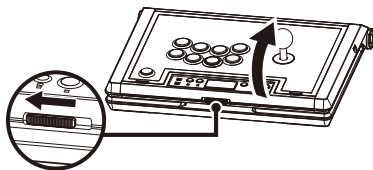

- 2) Open the housing cover and take out the USB cable.

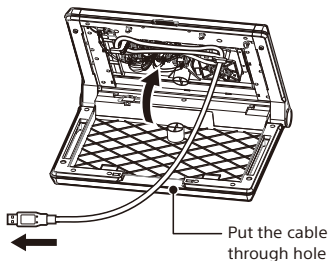

- 3) Pass the USB cable through the cable hole and close the lid.

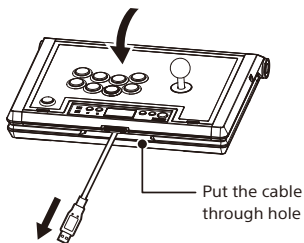

● Complete the steps in reverse to store the cable back into the housing cover.

- Be careful not to get your hands, fingers, hair, cables, etc. caught when opening or closing the housing cover.
- Wrap the USB cable around the designated pins before closing the housing cover.

② Set the Hardware Toggle Switch to the desired platform and plug in the USB cable.

- Do not plug in the USB cable while pushing any buttons, switches, or moving the joystick.
- When plugging in the USB connector, ensure that it is facing the correct direction.



* PC compatibility not endorsed by Sony Interactive Entertainment.



③ Press the PS Button.

Troubleshooting

If this product does not function as desired, please check the following:

① Pushing the PS Button does not turn on the PlayStation®5 console / PlayStation®4 console

Due to the specifications of this product, the PlayStation®5 console / PlayStation®4 console will not turn on when the PS Button is pressed.

For PlayStation®5 console : Push the Power Button on the PlayStation®5 console or press the PS Button on the DualSense™ Wireless Controller that is paired to the console.

For PlayStation®4 console : Push the Power Button on the PlayStation®4 console or press the PS Button on the DUALSHOCK®4 Wireless Controller that is paired to the console.

② PS Button does not responding during gameplay

Please check the Hardware Switch. When using the PlayStation®5 console or PlayStation®4 console, change the switch to "PS4" or "PS5" accordingly.

* Set the Hardware Switch before connecting to the console.

The product may not work properly if the switch is changed while connected to the console.

③ Controller is responsive on the Home Screen, but not during gameplay

Please make sure the controller is signed into the same account that was used to start the software. Please note that this product may not function with some PlayStation®5 console or PlayStation®4 console software.

For more information, please see the FAQ section on our website.

④ Controller is not responding even when pushing the PS Button

Cannot be used to initialize/configure a brand new PlayStation®5 console or PlayStation®4 console after turning on for the first time.

For PlayStation®5 console : Use the DualSense™ Wireless Controller to set up the console.

For PlayStation®4 console : Use the DUALSHOCK®4 Wireless Controller to set up the console.

⑤ Hardware Switch / Keylock Switch are not functioning properly

Check that the switch (Hardware Switch & Key Lock Switch) are set to the correct option. Please check the switch before use so that gameplay is not interrupted.

This user manual focuses on use with the PlayStation®5 console and PlayStation®4 console, but this product can also be used on a PC following the same instructions.

Included

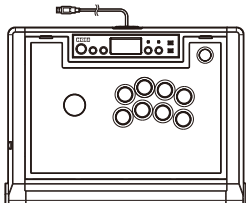

Controller ×1

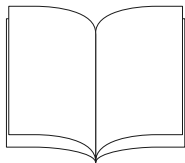

Instruction Manual ×1

Platform

PlayStation®5 console, PlayStation®4 console, PC*

* PC compatibility not endorsed by Sony Interactive Entertainment.

System requirements | USB Port, Internet Connection

* Functions as PC controller through XInput.
This product does not support DirectInput.

Important

Before using this product with your PlayStation®5 console or PlayStation®4 console, please read the included instructions carefully.
Please check that your PlayStation®5 console or PlayStation®4 console is updated to the latest system software.

Layout

Caution

- The PS5™ console and PS4™ console cannot be turned on with the PS Button.
- The PS Button cannot be used to return from PlayStation®5 Rest Mode or PlayStation®4 Standby Mode.
- Do not press any buttons, switches or the joystick when returning from PlayStation®5 Rest Mode or PlayStation®4 Standby Mode.
- The headset jack is not compatible with PC.
- The Touchpad and Touchpad Button are not compatible with PC.

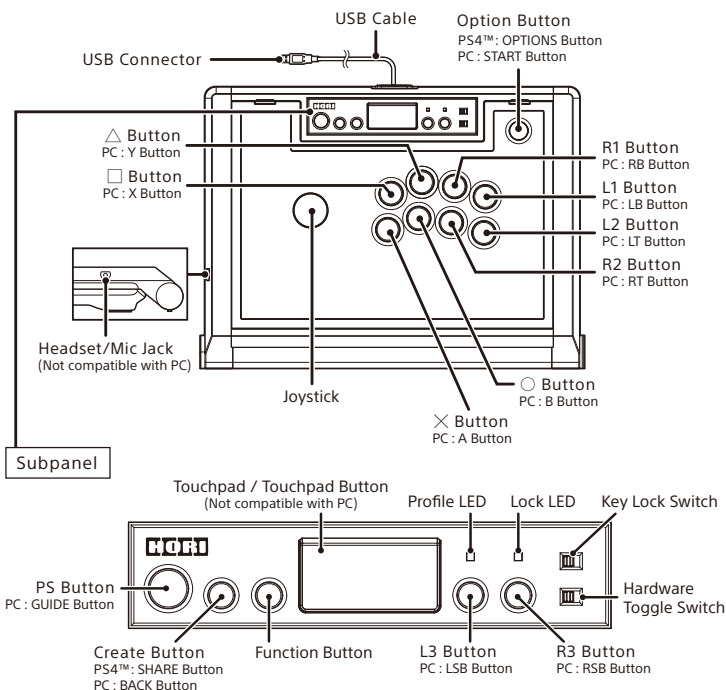

LOCK Switch

Some inputs can be disabled by using the LOCK Switch.
In LOCK Mode, the functions listed in the table below are disabled.



PSS™ / PS4™	PC
PS Button Option Button / OPTIONS Button Create Button / SHARE Button	GUIDE Button START Button BACK Button

Headphone/Mic Jack

A headset or headphones can be connected by plugging the product in to the headphone/mic jack.
(Not compatible with PC)

- ✓ Do not use high volume settings for an extended period of time.
- ✓ Be sure to turn down the volume before connecting a headset / headphones.

Profile

Use the Function Button to switch profiles (profiles can be set via the HORI Device Manger app).

- Please refer to the section "Download App" on the next page for more information on the HORI Device Manager App

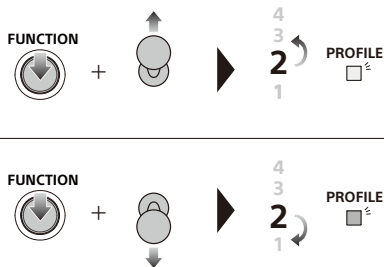

The Profile LED will change based on Profile setting.

Profile	Profile LED
1	Green
2	Red
3	Blue
4	White

Download App

『HORI Device Manager』

Please download and install the “HORI Device Manager” from this product’s website using your PC.

URL : <https://hori.jp/manual/p5/spf-013/>

The following features can be adjusted in the app:

- D-Pad/ Analog Stick Function
- Assign Mode
- Profile

Maintenance and Design Customization

Open up the housing cover to access the buttons and joystick for customization and maintenance. Open up the top panel cover to replace and customize the top panel artwork.



• Please note that the warranty may not cover damages caused by user negligence.

- Please make sure the USB cable is not connected to a PlayStation®5 console, PlayStation®4 console, or PC while performing maintenance on the controller.
- Do not remove buttons or connectors during gameplay.

How to Open the Housing Cover

- ① Open up the housing cover by sliding the latch.

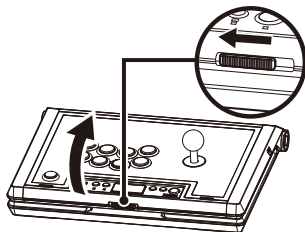

- ② Fold the housing cover back to stand upright.

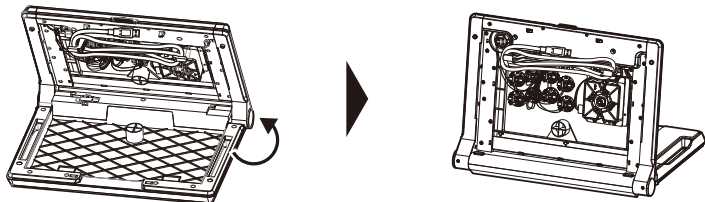

When performing maintenance, please refer to the "How to Remove a Button" section and the "Cable Wiring Diagram" as shown below.

How to Remove Buttons

- 1) Remove the quick disconnect blade connectors connected to each button.
 - When removing the quick disconnect blade connectors, remove while pressing the area shown in the diagram to the right.
- When installing a button, insert the blade connectors as far as it will go. Refer to the cable wiring diagram below when wiring each button.

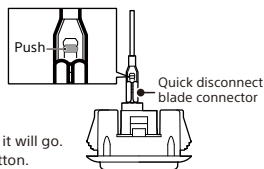

- 2) As shown in the image to the right, push the two stoppers gradually to remove the button.

- Parts may be damaged if too much force is used.
- Be careful not to cut your hands on the edges of the button holes on the housing cover.

- When installing a button, push the button in until the stopper clicks into place.

- After installing, make sure that there is no gap between the button and housing cover.

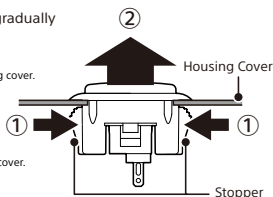

Cable Wiring Diagram

The cable wiring is as shown in the diagram below.

If you do not know the mounting position of the quick disconnect blade connectors after inserting and removing it, refer to the cable wiring diagram below.

- The diagram orientation shown is the inside when the housing cover is opened.

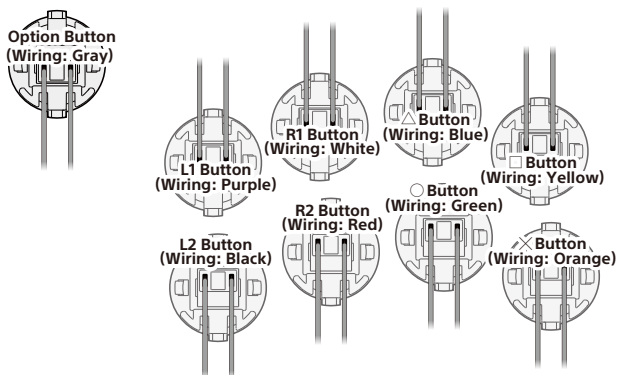

How to Change the Design

- ① Open the housing cover, place it on a stable surface, and remove the buttons (9) shown in the diagram to the right.

△ Button, ○ Button, × Button, □ Button
L1 Button, L2 Button, R1 Button, R2 Button

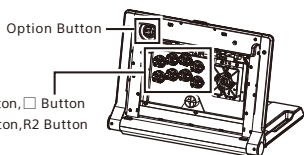

- ② As shown in the diagram below, remove the screws (8 screws) and joystick ball top.

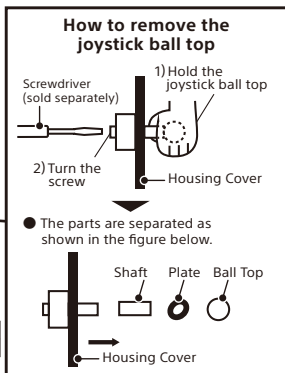
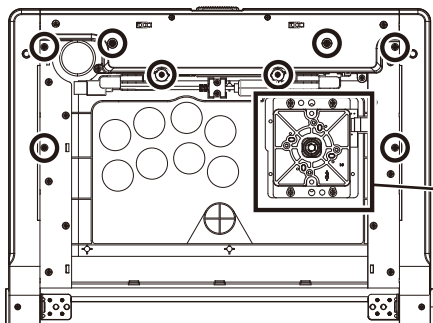

- ③ Open the frame and replace the design sheet.

- Do not remove the transparent cover.
If it comes off, reattach it according to the groove on the frame.

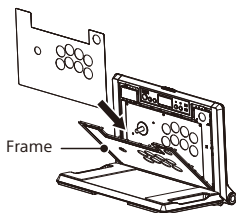

- ④ Close the frame, put the buttons, screws, and joystick back to their original state, and close the housing cover.

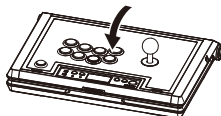

Main Features

External Dimensions	: 410mm × 300mm × 120mm
Weight	: 2.7kg
Cable Length	: 3.0m
Joystick	: HAYABUSA
Button (△ Button, ○ Button, × Button, □ Button, L1 Button, L2 Button, R1 Button, R2 Button)	: HAYABUSA
Button (Option Button)	: HORI Button

Simplified Declaration of Conformity

Hereby, HORI declares that this product is in compliance with Directive 2014/53/EU.

The full text of the EU declaration of conformity is available at the following internet address:

<https://hori.co.uk/consumer-information/>

For UK: Hereby, HORI declares that this product is in compliance with the relevant statutory requirements.

The full text of the declaration of conformity is available at the following internet address:

<https://hori.co.uk/consumer-information/>

THE FCC WANTS YOU TO KNOW

This device complies with part 15 of the FCC Rules. Operation is subject to the following two conditions: (1) This device may not cause harmful interference, and (2) this device must accept any interference received, including interference that may cause undesired operation.

NOTE: This equipment has been tested and found to comply with the limits for a Class B digital device, pursuant to part 15 of the FCC Rules. These limits are designed to provide reasonable protection against harmful interference in a residential installation. This equipment generates, uses and can radiate radio frequency energy and, if not installed and used in accordance with the instructions, may cause harmful interference to radio communications. However, there is no guarantee that interference will not occur in a particular installation. If this equipment does cause harmful interference to radio or television reception, which can be determined by turning the equipment off and on, the user is encouraged to try to correct the interference by one or more of the following measures:

- Reorient or relocate the receiving antenna.
- Increase the separation between the equipment and receiver.
- Connect the equipment into an outlet on a circuit different from that to which the receiver is connected.
- Consult the dealer or an experienced radio/TV technician for help.

The normal function of the product may be disturbed by strong electro-magnetic interference. If so, simply reset the product to resume normal operation by following the instruction manual (How to connect). In case the function does not resume, please relocate to an area which does not have electro-magnetic interference to use the product.

The wires are not to be inserted into socket-outlets.

The packaging must be retained since it contains important information.

PRODUCT DISPOSAL INFORMATION

Where you see this symbol on any of our electrical products or packaging, it indicates that the relevant electrical product or battery should not be disposed of as general household waste in Europe. To ensure the correct waste treatment of the product and battery, please dispose of them in accordance with any applicable local laws or requirements for disposal of electrical equipment or batteries. In so doing, you will help to conserve natural resources and improve standards of environmental protection in treatment and disposal of electrical waste. Applicable to EU countries and Turkey only.



EU and Turkey only

US

Warranty

HORI warrants to the original purchaser that the product purchased new in its original packaging shall be free of any defects in material and workmanship for a period of 1 year from the original date of purchase. If the warranty claim cannot be processed through the original retailer please contact HORI customer support directly at info@hori-usa.com. Please visit <http://stores.horiusa.com/policies/> for warranty details.

EU

Warranty

For all warranty claims made within the first 30 days after purchase, please check with the retailer where the original purchase was made for details. If the warranty claim cannot be processed through the original retailer or for any other inquiries pertaining to our products, please contact HORI customer support directly at info@horiuk.com.

"PS", "PlayStation", "PS5", "PS4", "DualSense" and "DUALSHOCK" are registered trademarks or trademarks of Sony Interactive Entertainment Inc.

All other trademarks are the property of their respective owners.

Manufactured and distributed under license from Sony Interactive Entertainment.