

**EN: Elektronik building set**

Set is powered by 4 AAA batteries (not included). Toy is meant for kids 8 years old and older. Study the manual thoroughly before the first use. Especially the category about what to be aware of and how to clean the contacts.

Warning: Toy is unsuitable for kids up to 3 years of age because it contains small parts. Producer: 3Dsimo s.r.o., Praha 9, K Žižkovu 282/9, 19800, www.boffinmagnetic.com
Manual in the language of your preference on the link:
www.boffinmagnetic.com/manual

**CZ: Elektronická stavebnice**

Stavebnice na 4x AAA baterie (nejsou součástí balení). Hračka je určena pro děti od 8 let. Před použitím si pečlivě prostudujte návod. Zejména kategorii, na co si dát pozor a jak provádět čistění.

Upozornění: Hračka není určená pro děti do 3 let, protože obsahuje malé části. Výrobce: 3Dsimo s.r.o., Praha 9, K Žižkovu 282/9, 19800, www.boffinmagnetic.com
Manuál v příslušné jazykové mutaci naleznete online na odkazu:
www.boffinmagnetic.com/manual

**PL: Elektroniczny zestaw konstrukcyjny**

Zestaw na 4 baterie AAA (brak w zestawie). Zabawka przeznaczona jest dla dzieci od 8 lat. Przed użyciem przeczytaj uważnie instrukcję. Zwłaszcza rozdział, na co zwrócić uwagę i jak przeprowadzić czyszczenie.

Ostrzeżenie: Zabawka nie jest przeznaczona dla dzieci poniżej 3 roku życia, ponieważ zawiera małe części. Producent: 3Dsimo s.r.o., Praha 9, K Žižkovu 282/9, 19800, www.boffinmagnetic.com
Instrukcję w odpowiedniej wersji językowej można znaleźć online pod linkiem:
www.boffinmagnetic.com/manual

**DE: Elektronisches Kit**

Das Kit verwendet 4x AAA-Batterien (nicht enthalten). Baukasten ist konzipiert für Kinder ab 8 Jahre. Lesen Sie die Anweisungen vor dem Gebrauch gründlich durch. Besonders die Kategorie, worauf zu achten und wie die Reinigung durchzuführen.

Beachtung: Das Spielzeug ist nicht für Kinder bis 3 Jahre konzipiert. Hersteller: 3Dsimo s.r.o., Praha 9, K Žižkovu 282/9, 19800, www.boffinmagnetic.com
Das Manual in der betreffenden Sprache finden Sie am Link:
www.boffinmagnetic.com/manual

**HU: Elektronikus építőkészlet**

Az építőkészlet működtetéséhez 4 AAA elem szükséges. A csomag elemet nem tartalmaz. A játék 8 éves kortól ajánlott. Használat előtt olvassa el figyelmesen a használati útmutatót. Különösen a tisztítás és karbantartás kategóriát.

Figyelem! Nem alkalmas 3 éves kor alatti gyermekek számára. Fulladásveszélyes!
Cyártó: 3Dsimo s.r.o., Praha 9, K Žižkovu 282/9, 19800, www.boffinmagnetic.com
A kézikönyvet a megfelelő nyelvi változatban online található ezen a linken:
www.boffinmagnetic.com/manual

**FR: Kit de construction électronique**

Le kit utilise 4 piles AAA (non inclus). Le jeu est destiné pour les enfants à partir de 8 ans. Lisez le mode d'emploi attentivement avant utilisation. Notamment la catégorie de ce qu'il faut faire attention et comment nettoyer le produit.

Attention: le jouet n'est pas destiné pour les enfants jusqu'à 3 ans. Fabricant: 3Dsimo s.r.o., Praha 9, K Žižkovu 282/9, 19800, www.boffinmagnetic.com
Le mode d'emploi dans la langue correspondante se trouve sur le lien:
www.boffinmagnetic.com/manual

**IT: Kit elettronico**

Il kit utilizza 4 batterie AAA (non incluso). Il giocattolo è destinato a bambini dagli 8 anni. Leggere attentamente le istruzioni prima dell'uso. Soprattutto le avvertenze e i consigli su come effettuare la pulizia.

Avvertimento: Il giocattolo non è destinato a bambini di età inferiore a 3 anni, poiché contiene piccole parti. Produttore: 3Dsimo s.r.o., Praha 9, K Žižkovu 282/9, 19800, www.boffinmagnetic.com
Il manuale nella versione linguistica pertinente si trova al link:
www.boffinmagnetic.com/manual

**ES: Kit electrónico**

Kit para 4 pilas AAA (no incluido). El juguete es para niños a partir de 8 años. Lea atentamente las instrucciones antes de usar. Especialmente la categoría de qué evitar y cómo realizar la limpieza.

Advertencia: el juguete no está destinado a niños menores de 3 años, ya que contiene piezas pequeñas. Fabricante: 3Dsimo s.r.o., Praha 9, K Žižkovu 282/9, 19800, www.boffinmagnetic.com
El manual se puede encontrar en línea en:
www.boffinmagnetic.com/manual

HI!

You have received a unique electronic kit, with which you can build fun and sometimes even almost crazy projects.

In this book you will find 100 sample builds.

Every month we are going to add another 10 new projects to our official website.

There are already more than 50 of them now.

You can find online projects at:

www.boffinmagnetic.com/community/projects

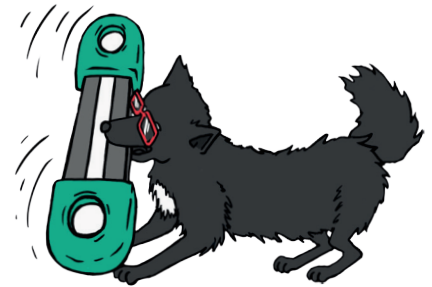

My name is Boffin Magnetic

I will accompany you throughout the book. From the simplest builds to the most complex ones. We can accomplish everything together and you will learn, too. I am going to teach you to understand electronic circuits and also how things work around us.

I am sure that you cannot wait to build your first circuit.

But before you start, turn to the next page!



ATTENTION!



Before you start building, read what you should definitely NOT do to avoid damaging the kit:

Battery type

Use only AAA 1.5V batteries!
(These batteries are not included in the kit.)

Battery polarity

Always insert the batteries with the correct polarity,
i.e. plus to \oplus and minus to \ominus .

Replacing batteries

Replace AAA batteries regularly.
Remove defective batteries.
Do not mix old and new batteries.

Never!

Never connect the circuit or any component to household electrical sockets (risk of electric shock).

Never connect the \oplus and \ominus contacts directly on the battery component, otherwise a short circuit will occur and damage the batteries (the batteries will start to heat up quickly).

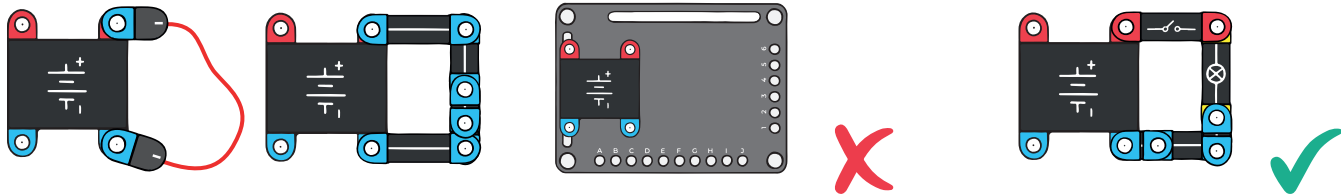

Always!

Always make sure that the build is connected correctly according to the instructions. Never reverse the polarity of both batteries and other components where the contacts are marked with a \oplus and \ominus .

The package contains small parts.

There is a risk of swallowing. Not intended for children under 3 years.

BASIC TROUBLESHOOTING:

1. Wrong build

Most problems are due to a wrong build. Therefore, always carefully check that the circuit built corresponds to the sample drawing.

2. Polarity \oplus and \ominus

Make sure that components with explicitly indicated positive / negative contacts are positioned in accordance with the sample drawing.

3. Bad contact

If the connection you have created does not have an adequate contact, you should gently move and push the components.

4. You may build your own projects at your discretion

3Dsimo s.r.o. cannot be held liable for any potential damage caused to components.

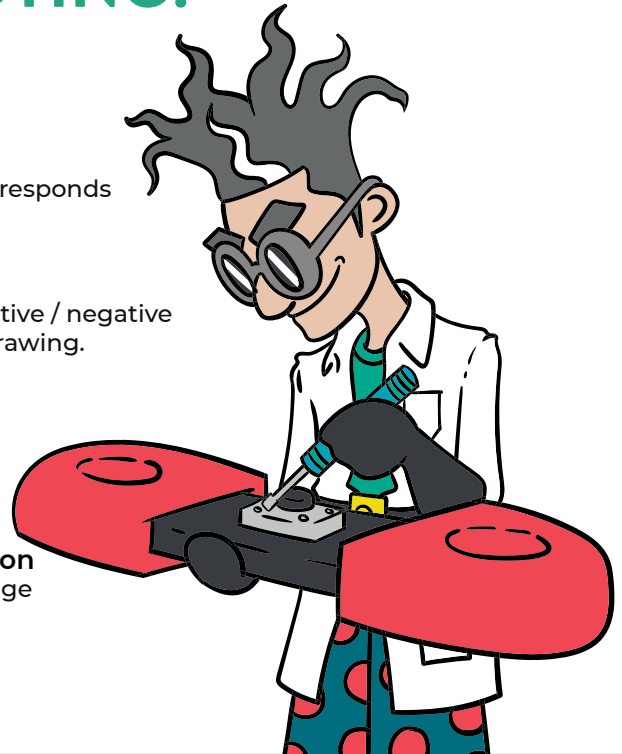

CLEANING:

Regularly clean magnetic contacts and the surfaces on which they rest.

Use the included pen with cleaning liquid or alternatively wet wipes for electronics or a piece of cloth soaked in alcohol or diluted dish detergent to clean components.

Over time, dirt or grease may adhere to the contacts, which may prevent the components from functioning properly (due to reduced conductivity).

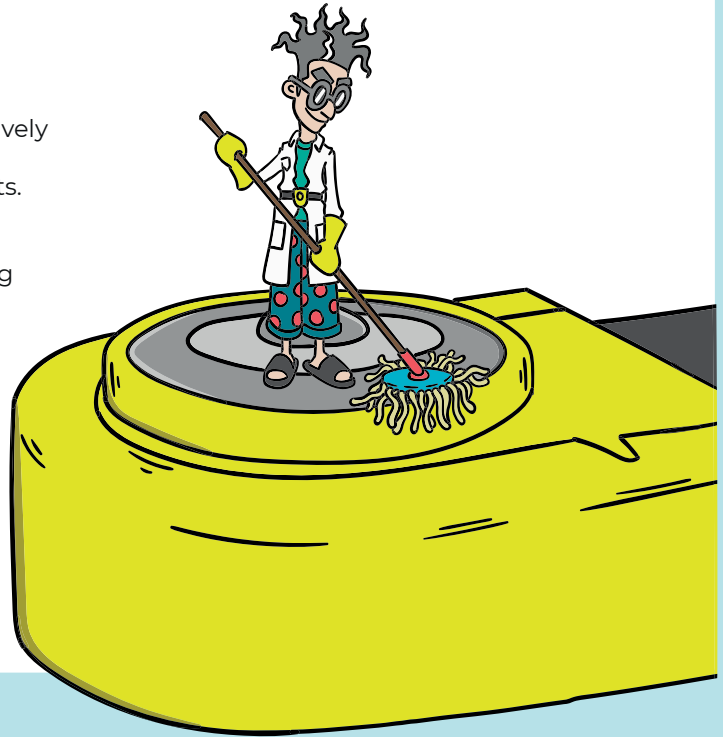

HOW IT WORKS

MAGNETIC BASE PLATE

It consists of several parts stacked on top of each other and represents a unique technology - a combination of magnetism, conductive surfaces and non-conductive space for placing components. You can build your project on both sides of the base plate to get an area larger than A4-size paper. Alternatively, you can buy another base plate and layer them on top of one another using conductive column spacers.

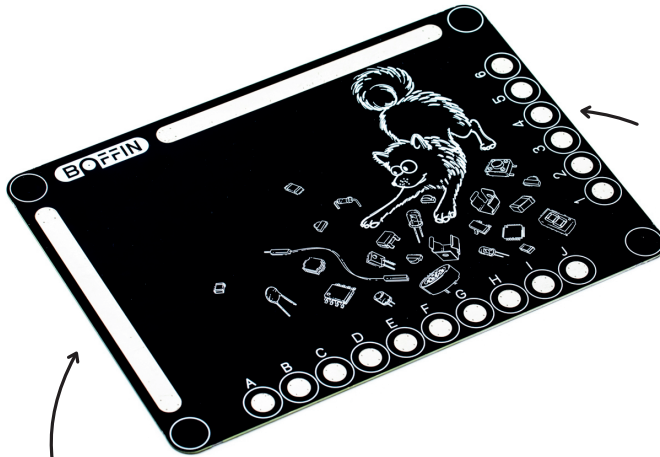

There are two long conductive strips that can be used for power supply; they are also connected to the other side of the base plate.

It is used to connect individual surfaces to the other side of the base plate.

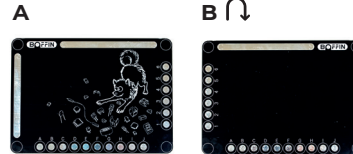



CONDUCTIVE TRACE

It is a simple component that is only used to interconnect the components with which you create a functional build. It consists only of a conductive track or path that should bring electricity from point A to point B.



(ON-OFF) SWITCH

It is a manually operated mechanical switch used to switch an electrical circuit on or off. In one position, a permanent conductive trace is made (ON), whereas in the other position the trace is open or broken (OFF).



BUTTON

It is a simple switch that is used to manually control electrical equipment. The circuit closes when the button is pressed.



CHANGEOVER SWITCH (A/B SWITCH)

It is an electronic component operating on a similar principle as the on-off switch. If we do not connect one terminal, we will create a simple switch. This component is used to switch the flow of current from the common contact to contacts A or B.



MAGNETIC REED SWITCH

The reed contact is a mechanical switch controlled by a magnetic field. If you bring a magnet close to the contacts, it will be connected, and thus a conductive trace will be made. After removing the magnet, the trace is disconnected.



CAPACITOR

It is a component used in electrical circuits to temporarily store an electric charge, and thus to store electrical energy - charge.



RESISTOR

One of the basic components without which no circuit and build can do. Its basic property is electrical resistance. The main reason for including a resistor in an electrical circuit is to limit the flow of electrical current through the circuit or to obtain a certain voltage drop for measuring non-electrical quantities.



PHOTORESISTOR

This is a light-sensitive component. This means that the more light shines on the component, the less resistance it will have. For example, a motor connected to a circuit will spin faster in high light. If you shade the photoresistor with your finger, a high resistance will cause the motor speed to decrease until it stops. With this component you can create a large number of interesting and experimental builds that will respond to illumination or its change, as the case may be.



POTENTIOMETER

It is a component that changes the resistance when its axis rotates; for this reason, it is used to directly control, for example, the volume or intensity of light. With the Boffin Magnetic kit, you will find that it can also be used as a steering wheel for controlling a racing game.

BULB



A light bulb is a simple device used to convert electrical energy to light. It works on the principle of heating a thin conductor (mostly a tungsten filament) by an electric current flowing through it. At high temperatures, the filament of a light bulb glows, but consumes most of the energy to radiate heat instead of light. For this reason, we nowadays mostly used light sources that are much more economical and efficient. In one of the builds, you can compare both types of radiators and test how much they heat up, shine and consume energy.

DIODE



The purpose of the diode is to let electric current flow only in one direction, and this is why the diode symbol is similar to an arrow. The diode contains two transitions – P and N – referred to as the anode and the cathode, respectively.

LED (LIGHT-EMITTING DIODE)



The LED has the main task to light up as efficiently as possible. It is a semiconductor device that can be connected in the forward or the reverse direction. If you connect the diode in the reverse direction, no current will flow through it and it will not light up. Current can flow through a diode connected in the forward direction, and it then lights up.

NPN/PNP TRANSISTOR



The main feature of a transistor is its ability to amplify an electric current. This simply means that small changes in input voltage or current can cause large changes in output voltage or current.



BUZZER

Due to the piezoelectric effect, this component emits a squeaky tone. This phenomenon occurs due to changing voltage at its contacts, which is applied to the crystal.



SPEAKER

The speaker converts electrical energy into acoustic pressure – in lay terms called the sound. Acoustic pressure changes generate acoustic waves, which stimulate the human auditory organ. Depending on the rate of change of the speaker's electric current, sound waves of different frequencies are generated. A person is able to perceive frequencies in the frequency range of from about 16 Hz to 20,000 Hz depending on the age and abilities of the individual.



MICROPHONE

A component enabling the conversion of an acoustic signal, or sound, to an electrical signal. Thanks to this, you can hear the singer at the concert even in the back rows.



JOYSTICK

The joystick replaces several buttons. If you need to move in all directions in a game and still jump, for example, you will need at least five buttons. The joystick can be a full replacement of all of those buttons and do even much more.

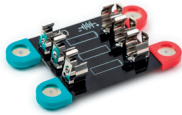

BATTERY

Galvanic cells, which represent batteries or accumulators, supply electricity to a circuit through an electrochemical reaction inside the cell. The cells differ in size, chemical composition and, thus, the output voltage. Without this component, no circuit would work for you.

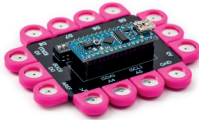

MICROCOMPUTER (THE BRAIN OF THE BOFFIN MAGNETIC KIT)

A component whose main function is to control the entire Boffin Magnetic kit; it can also be referred to as the brain. A miniature computer thanks to which you can play games or, for example, measure temperature and other quantities. If you are technically proficient, you can reprogram it at your discretion or upload new programs to it, which we are going to publish from time to time.



DISPLAY

A small OLED display with a resolution of 128 by 64 pixels and a size of 1.3". One pixel represents one small square on a black area, and when the correct squares light up, an image on the display is formed. The display is directly connected to the microcomputer by two data conductors named according to the corresponding terminals.

SYMBOLS

On each module you also have the electrotechnical symbol of the component, which is commonly used. For a better understanding, you will find below an explanation of which component, which brand it belongs to.



Conductive trace



(On-Off) Switch



Button



Changeover switch



Reed switch



Capacitor



Polarized capacitor



Resistor



Photoresistor



Potentiometer



Bulb



Diode



LED



NPN transistor



PNP transistor



Buzzer



Speaker



Microphone



Joystick

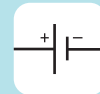

Battery

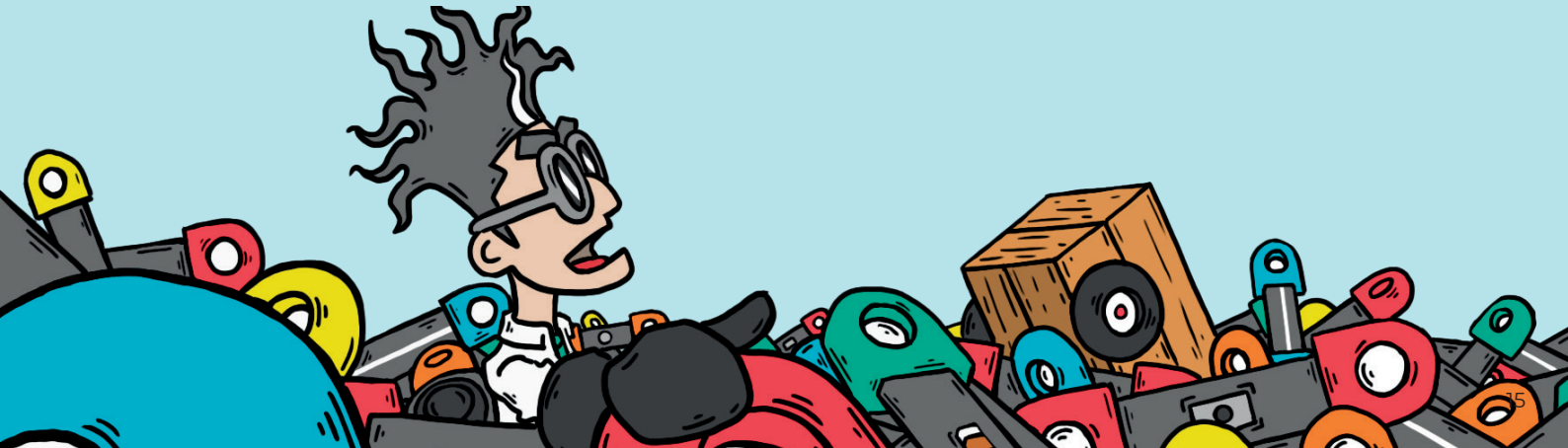

PROJECTS



BEGINNER



ADVANCED

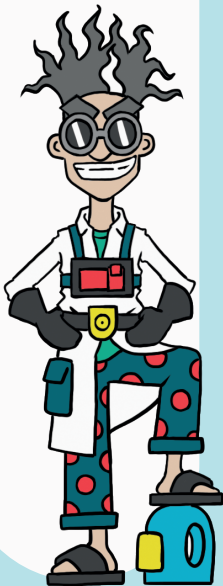

EXPERT



PROJECTS

1 LIGHT

L10 Light bulb with switch	21	L290 NPN amplifier with LED	40
L20 LED with switch	21	L300 NPN amplifier with LED in reverse direction	41
L30 Switch vs. button	22	L310 Amplifier with LED	42
L40 Serial connection of LEDs	22	L320 Switching with button II.	42
L50 Switching with button I.	23	L330 Adjustable power switch	43
L60 The LED lights up in one direction	24	L340 Safety button	43
L70 High luminosity with 100 Ω resistance	24	L350 Carbon button	44
L80 High luminosity with resistors con. in parallel	25	L360 Carbon potentiometer	45
L90 Controlling by photoresistor	26	L370 SE PNP amplifier with a LED and bulb	46
L100 Controlling by microphone	26	L380 PNP amplifier with LED in reverse direction	47
L110 Bulb controlled by a magnet	27	L390 Emitter follower with NPN	48
L120 LED controlled by a magnet	27	L400 SE amplifier with NPN and LEDs	48
L130 Switching LEDs	28	L410 SE amplifier with PNP and bulb	49
L140 Changing a current by LED	29	L420 Emitter follower with PNP	49
L150 Connecting a light bulb and LED in series	30	L430 Raising cur. by base with SC amplifier with PNP	50
L160 Connecting a light bulb and LED in parallel	30	L440 SE amplifier with NPN and bulb	50
L170 LED bypass	31	L450 Brightness control	51
L180 Polarity indicator	32	L460 Two-finger touch lamp	51
L190 Semiconductor diode function – forward direction	33	L470 Controlling NPN transistor by light I.	52
L200 Semiconductor diode function – reverse direction	33	L480 Controlling NPN transistor by light II.	53
L210 Changing brightness smoothly I.	34	L490 Controlling PNP transistor by light I.	54
L220 Changing brightness smoothly II.	35	L500 Controlling PNP transistor by light II.	55
L230 Conductivity detector I.	36	L510 Standard transistor circuit	56
L240 Human body conductivity detector	36	L520 Flashing light bulb	57
L250 Conductivity detector II.	37	L530 Night light automatic switch-off I.	58
L260 Water detector	38	L540 Night light automatic switch-off II.	59
L270 Light alarm	39	L550 Night light automatic switch-off III.	60
L280 Intensive light alarm	39	L560 Schmitt circuit	61
		L570 Night light automatic switch-off IV.	62
		L580 Night light automatic switch-off V.	63
		L590 Railroad crossing	64
		L600 Twilight switch	65

2 SOUND

S10 Multiple-tone generator I.	67
S20 Multiple-tone generator II.	68
S30 Multiple-tone generator III.	69
S40 Engine sound	70
S50 Voice-controlled light	71
S60 Morse code	72
S70 Applause LED	72
S80 Buzzing in the dark	73
S90 Adjustable tone generator	74
S100 Photosensitive electronic organ	75

3 ENERGY

E10 Capacitors connected in series	77
E20 Capacitors connected in parallel	78
E30 Your own battery I.	79
E40 Your own battery II.	79
E50 Your own battery III.	80
E60 Your own battery IV.	80
E70 Charging and discharging the capacitor I.	81
E80 Charging and discharging the capacitor II.	82

4 MEASUREMENT

M10 Compression meter	84
M20 Voltage measurement	85
M30 Low current measurement	86
M40 Diode forward direction measurement	87
M50 LED forward direction measurement	88
M60 Luminance level measurement	89

5 GAMES

G10 Fast reflexes	91
G20 Platform game with Boffin	92
G30 Ping pong multiplayer	93
G40 Tetris	94
G50 Roxy catches dice	95
G60 Ping pong singleplayer	96
G70 Shooting down the dice	97
G80 Space shooter	98
G90 Racing game I.	99
G100 Racing game II.	100
G110 Snake	101
G120 Jumping with Boffin	102
G130 Logic game with Boffin	103

6 FUNCTIONS

F10 Kitchen timer	105
F20 Clock	106
F30 Pass counter	107

1 LIGHT

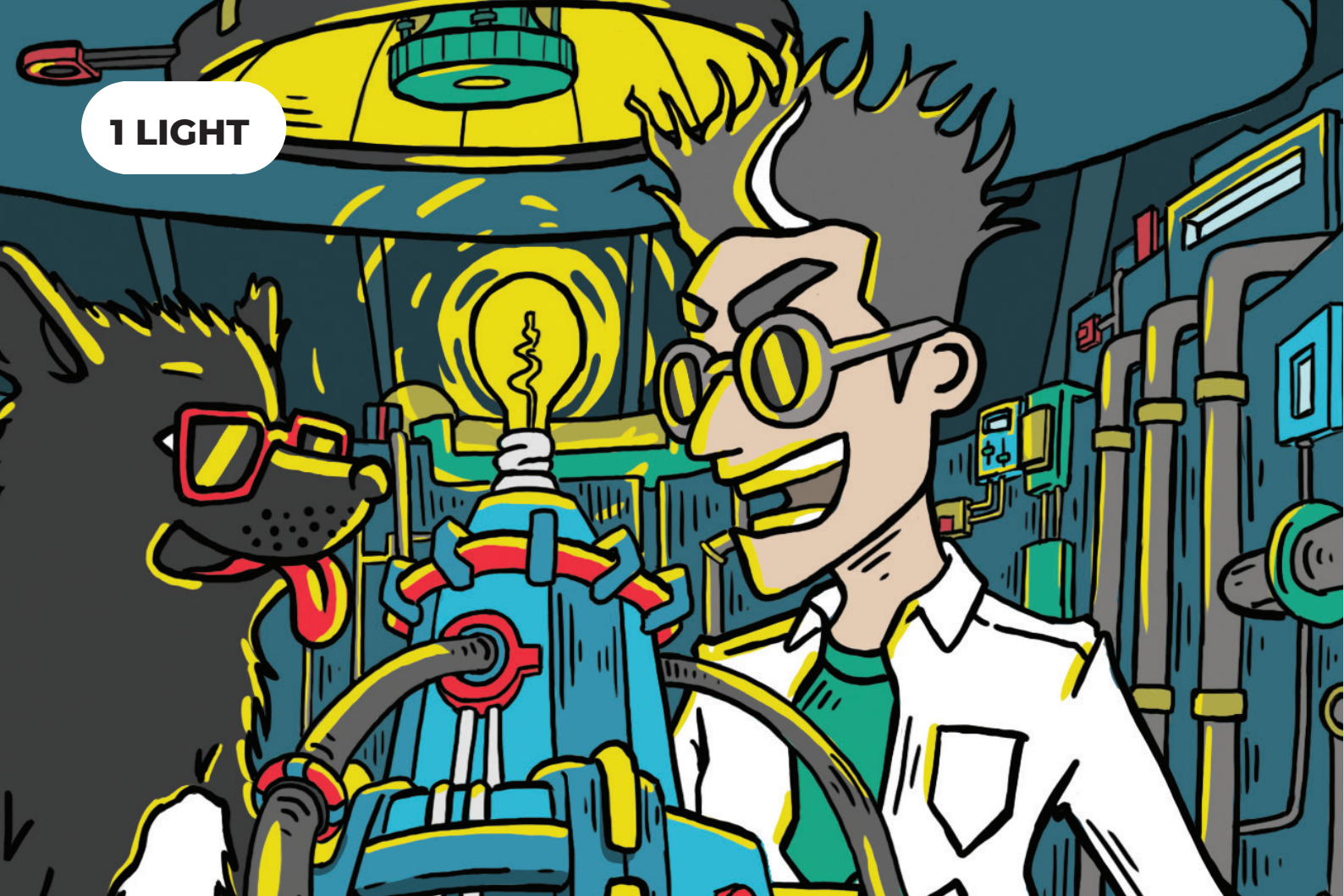

L10 LIGHTBULB WITH SWITCH



1x bulb

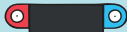

1x battery



1x
2x

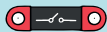

1x switch

A basic build that demonstrates how the electronic circuit in principle works. The switch acts as a circuit breaker, the bulb generates light and the jumpers close the circuit so that electric current can flow through it. The battery is an integral part of the circuit and serves as a source of energy for the light bulb.

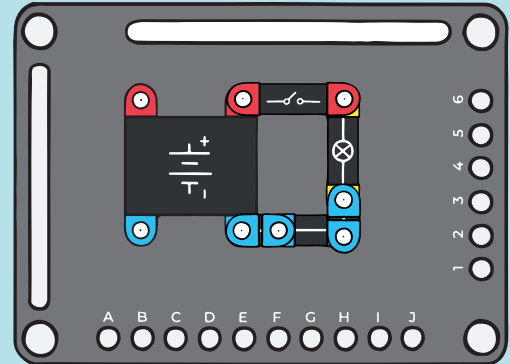

L20 LED WITH SWITCH



1x LED



1x resistor 1kΩ

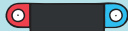

1x battery



1x
3x



1x switch

A basic build with an LED as a light source. LEDs are not adjusted to the supply voltage of a battery, therefore is necessary to add a serial resistor to the build. That will lower the current flow in the circuit. Otherwise the LED would be destroyed.

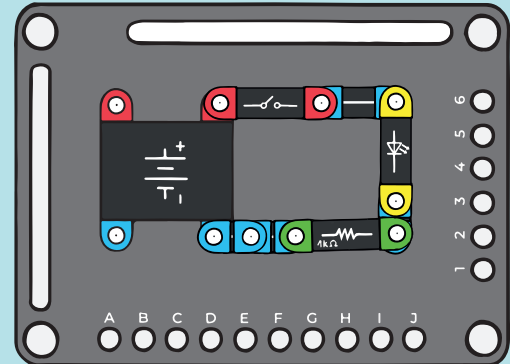

L30 SWITCH VS. BUTTON

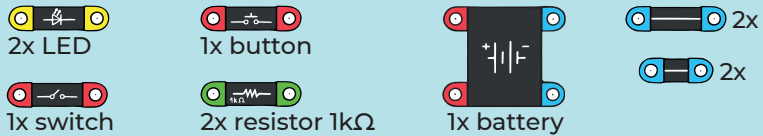

The basic components in the circuit include switches and buttons that control the current flow. The switch has two stable positions (OFF and ON) and the current flows only in the ON position. The current flows through the button only when it is pressed.

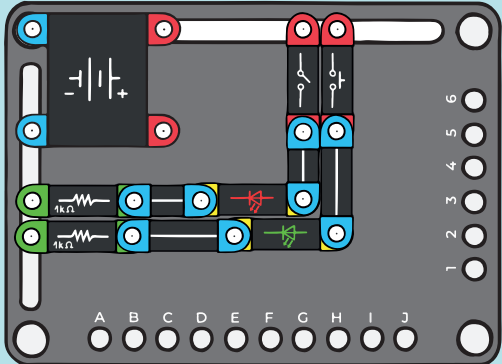

L40 SERIAL CONNECTION OF LEDS

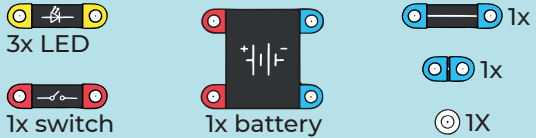

The objective is to test that by connecting 3 LEDs in series, none of them will light up because the voltage drop across each of the diodes is in total greater than the supply voltage of the batteries, which is 6V. Here you do not need to worry about destroying the LEDs without adding a resistor since almost no current will flow through them.

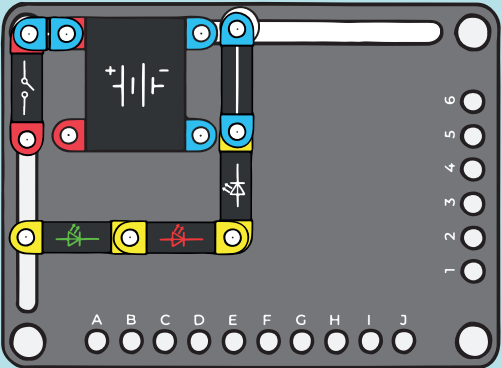

L50 SWITCHING WITH BUTTON I.



1x switch



1x button

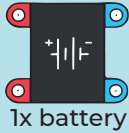

1x battery



1x 2x



1x resistor 1kΩ



2x LED



2x



4x

In this circuit, a red and a white LED are connected in parallel with a common resistor. When the switch is closed, the white LED lights up. If you press the button, you connect the red LED to the white LED in parallel. Since the white LED needs a higher voltage than the red one to light up, connecting the red LED will lower the voltage. The white LED goes out and the red LED lights up. The button visually acts as a changeover switch in this case even though it does not have a changeover contact.

1.

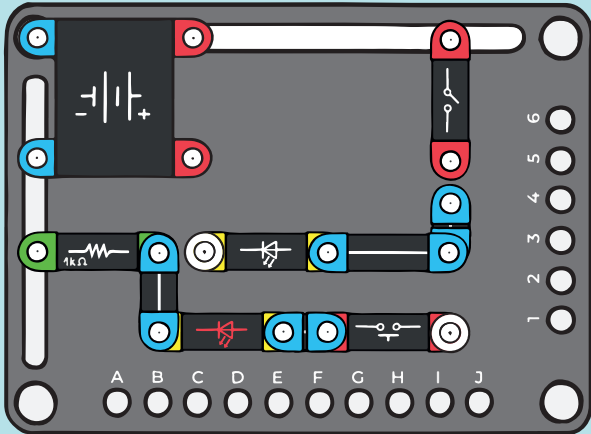

2.

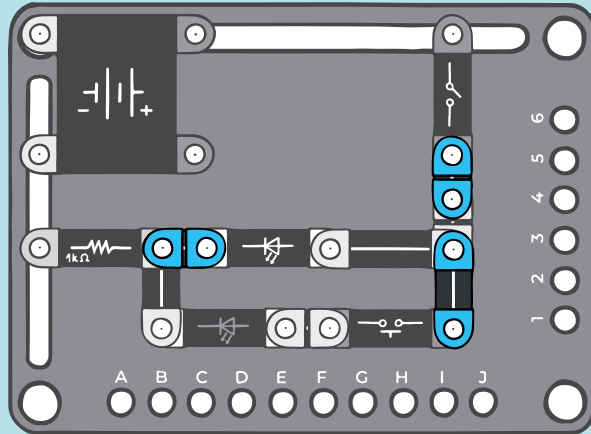

L60 LED LIGHTS UP IN ONE DIRECTION

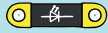

1x LED



1x resistor 1kΩ

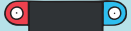

1x battery



1x



3x



1x switch

A LED is a semiconductor device (made up of two transitions called P and N) that conducts an electric current in only one forward direction (from the cathode (N) to the anode (P)). For this reason, the LED can only light up if connected in the forward direction, which is not the case in this circuit as the LED is connected in the reverse direction.

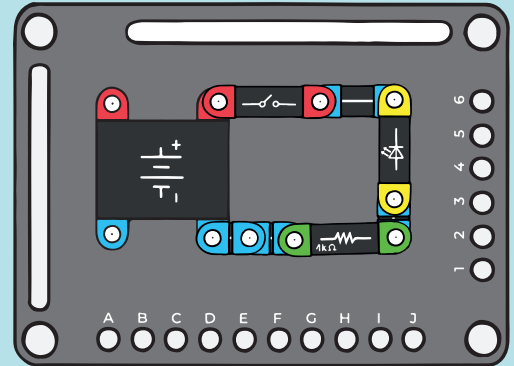

L70 HIGH LUMINOSITY WITH 100Ω RESISTANCE

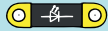

1x LED



1x resistor 100Ω

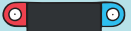

1x battery



1x



3x



1x switch

The LED light intensity is determined by the amount of current flowing through the circuit. A resistor included in the circuit blocks the current from flowing, and this allows you to adjust its magnitude. The smaller the resistance you insert into the circuit, the greater the current that will flow through the circuit and the brighter the LED light will be.

Warning: Never replace the ballast resistor for the LED with a plain conductive trace piece, otherwise you will destroy the LED.

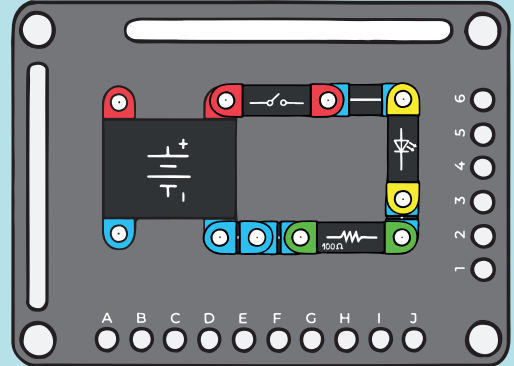

L80 HIGH LUMINOSITY WITH RESISTOR CONNECTED IN PARALLEL

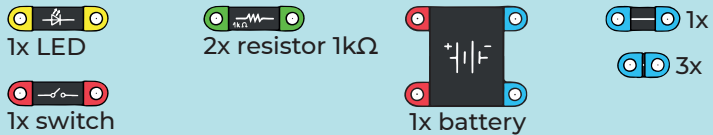

You can find the resistor as a component in the package in several values, and it is possible to connect them in parallel (next to one another) or in series (in a row). When resistors are connected in parallel, the total resistance value decreases. This is used in cases where we do not have the required value or it is not produced. In the case of two identical resistors, the resistance is halved, thus increasing the LED light brightness.

1.

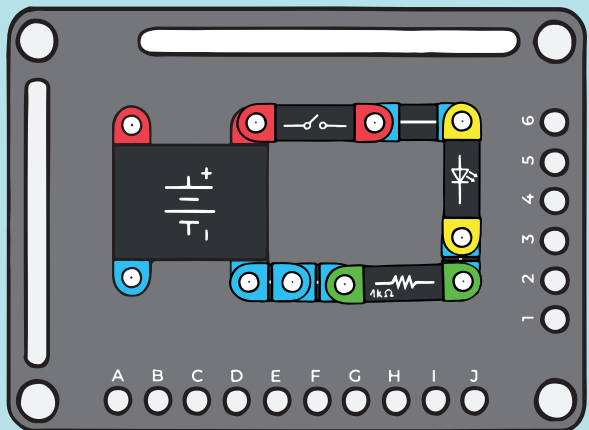

2.

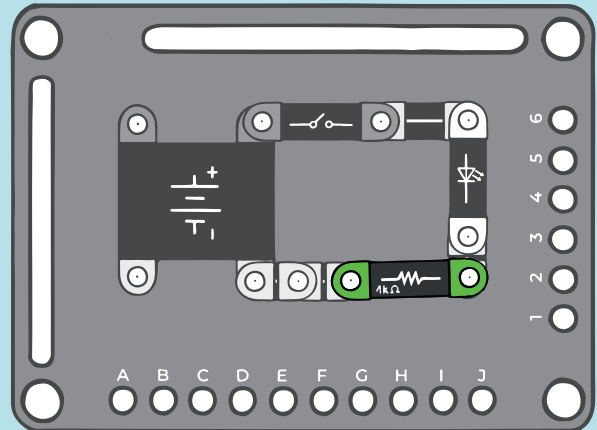

L90 CONTROLLING BY PHOTORESISTOR

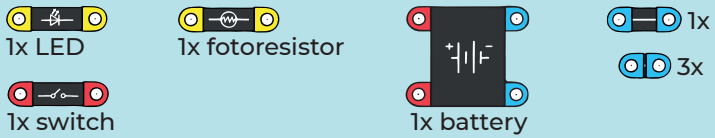

There are electronic components that respond to light. One of them is a photoresistor – its resistance changes with the intensity of incoming light. When you cover the photoresistor with your finger, its resistance increases. This reduces the current flowing through the circuit, which in turn decreases in the LED light intensity.

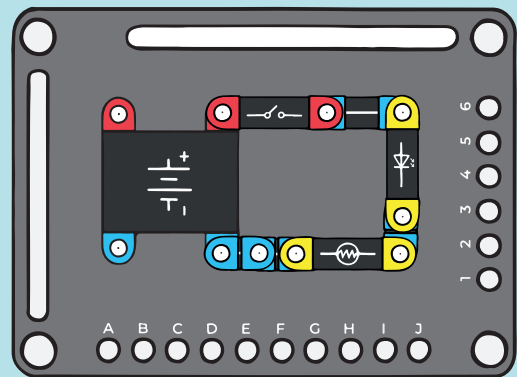

L100 CONTROLLING BY MICROPHONE



A microphone is a component that converts sound into an electrical signal. As a rule, the sound is converted into a diaphragm vibration, which is further evaluated as a change in resistance or capacitance. In the presented circuit, the microphone changes the current using the LED, whose light brightness reacts to the sound interacting with the microphone diaphragm.

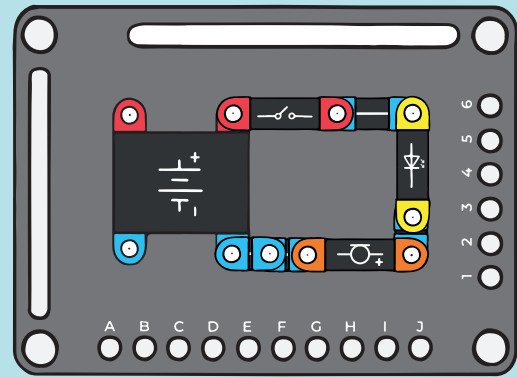

L110 BULB CONTROLLED BY A MAGNET

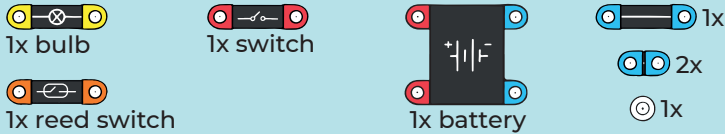

The electrical switch does not need to be just a manually operated component. A magnetic reed switch can serve as an alternative. It consists of two thin flexible steel contacts, usually in a glass flask. When the magnet approaches, the two contacts are magnetized and connect. This closes the electrical circuit and turns on the light bulb. After the magnet is moved away, the contacts open by their own elasticity. This interrupts the flow of electricity and the light goes out.

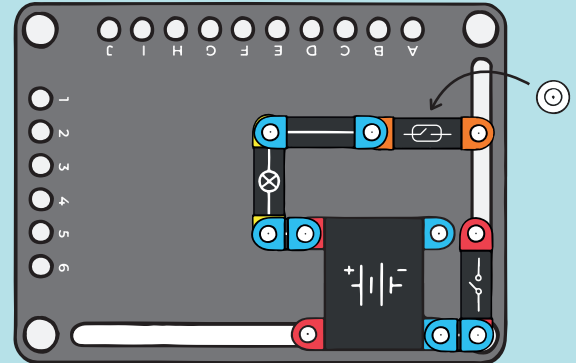

L120 LED CONTROLLED BY A MAGNET

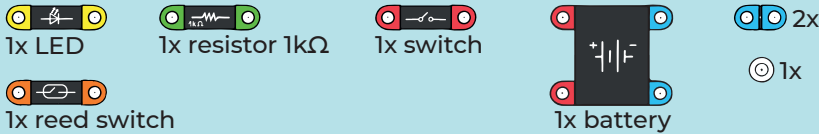

The magnetic reed switch can be used to directly switch a wide range of appliances. However, it is not suitable for large appliances with high current consumption as the contacts may slowly get burned or lose flexibility due to overheating. Although our small bulb represents a marginal load even for a small reed contact, it is always advantageous to minimize the current through the reed contact. Instead of a light bulb, we use a LED diode since it needs rather low current flow values to function.

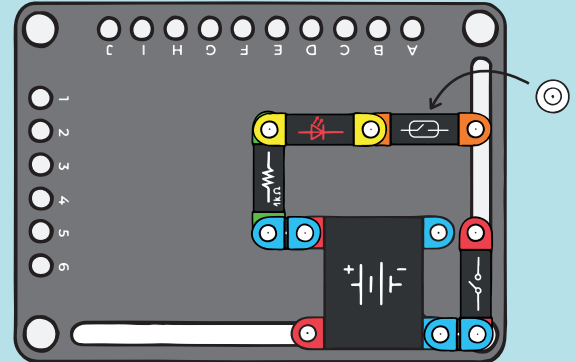

L130 SWITCHING LEDS



2x LED

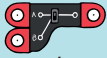

1x A/B switch

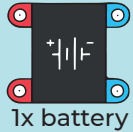

1x battery



1x



1x



2x



1x resistor 1kΩ

The changeover switch is a variant of the on-off switch that has both positions of the switching contact available. When the changeover switch is operated, the contact interrupts the current flow in one part of the circuit and, at the same time, closes another part of the circuit. The LED therefore lights up alternately, depending on the position of the changeover switch. However, only one LED is active at any point of time.

1.

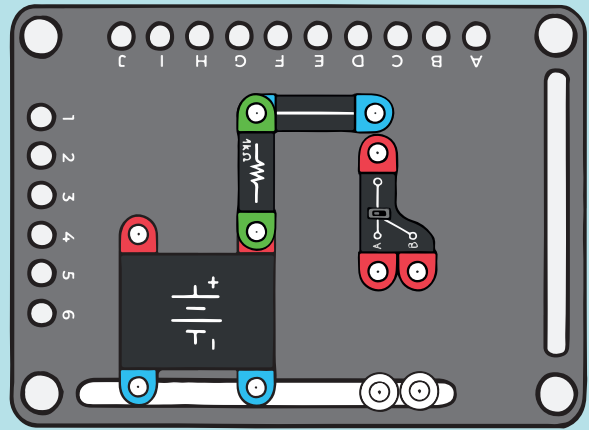

2.

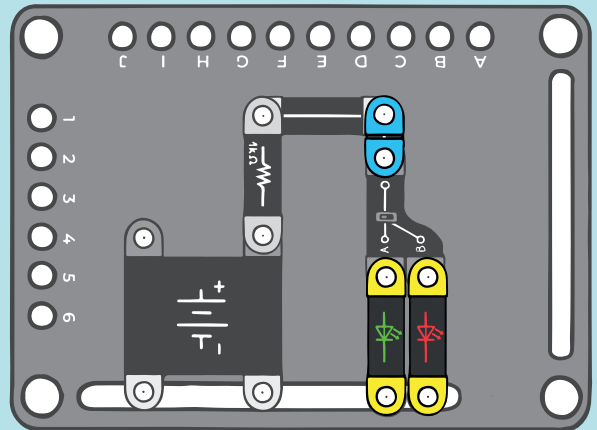

L140 CHANGING THE CURRENT BY LED



1x LED

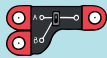

1x A/B switch



1x resistor 10kΩ

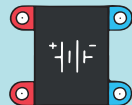

1x battery



1x



1x



2x



1x resistor 1kΩ

We do not have to change the LED light brightness by means of altering the current flowing through it by physically changing a component. We can use a changeover switch to change the ballast resistance for the LED. We have a choice of two values of the current that can flow through the LED, i.e. 2 variants of brightness.

1.

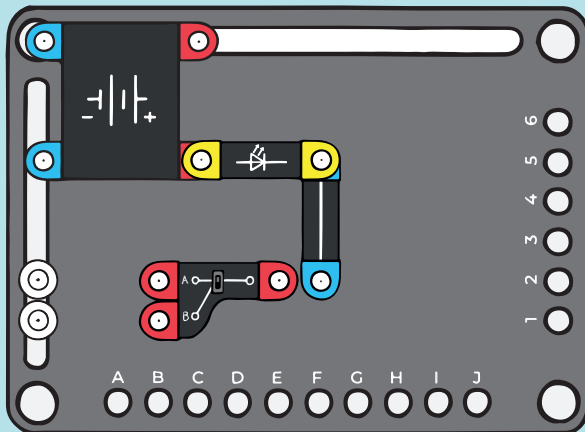

2.

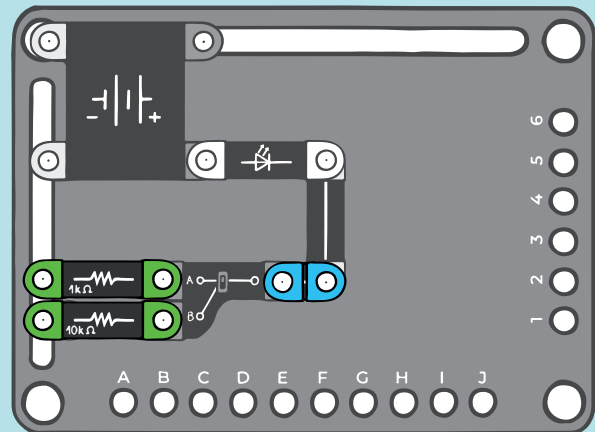



L150 CONNECTING A LIGHT BULB AND LED IN SERIES



1x LED



1x bulb

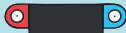

1x battery



1x



2x



1x switch



1x resistor 1kΩ

Connecting multiple appliances in a row. The same current flows through both appliances, but the battery voltage is divided between the two appliances. In our circuit, it is reflected in a low brightness of the bulb. In practice, a connection in series is used for the same appliances with the same consumption. One big disadvantage of connecting appliances in series is that the failure of any component will open the circuit, which you can simulate by unscrewing the bulb - the LED goes out.

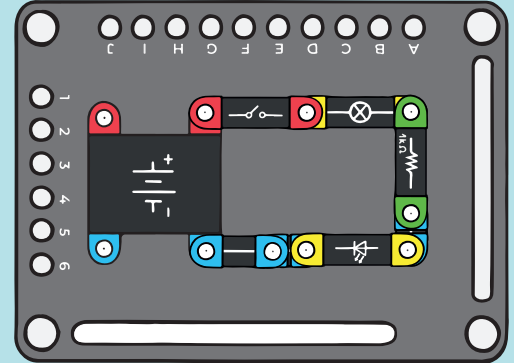

L160 CONNECTING A LIGHT BULB AND LED IN PARALLEL

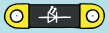

1x LED



1x bulb

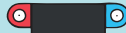

1x battery



1x



1x



1x switch



1x resistor 1kΩ

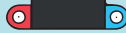

1x battery



4x

Connecting multiple appliances side by side. The total current drawn from the source is a sum of the partial currents taken. The voltage on both appliances is the same. If one appliance is disconnected from the circuit, it will not affect the rest, only the value of the current flowing through the circuit will decrease. Electricity is distributed to appliances exclusively in this way.

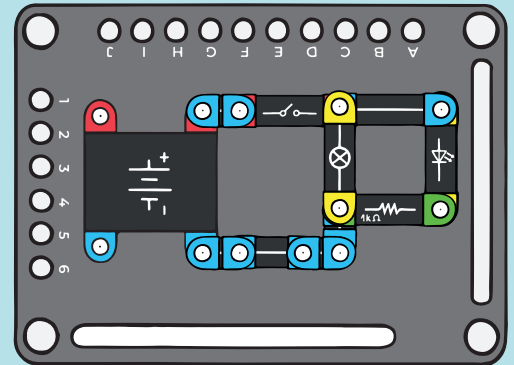

L170 LED BYPASS

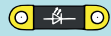

1x LED



1x button



1x battery



2x



1x resistor 1kΩ

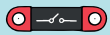

1x switch



2x

A button connected in parallel to the LED. When the button is not pressed, i.e. it is open, the LED light is on. If you press the button, you short-circuit the LED diode and it goes out. It stays off as long as the button is pressed and lights up again when the button is released. The ballast resistor not only protects the LED from excessive current, but also ensures that the button does not short-circuit the battery directly. The resistor thus limits the short-circuit current and protects the battery as well as the button from excessive current.

1.

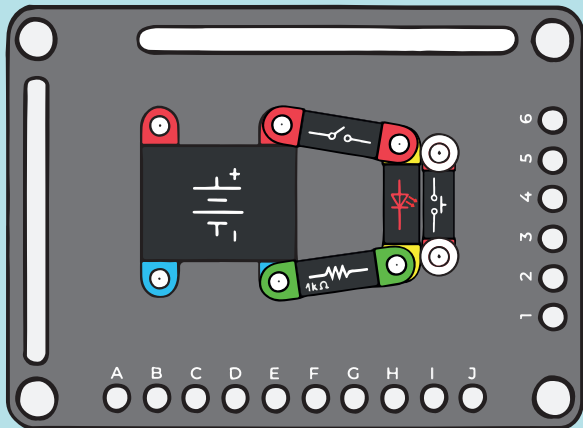

2.

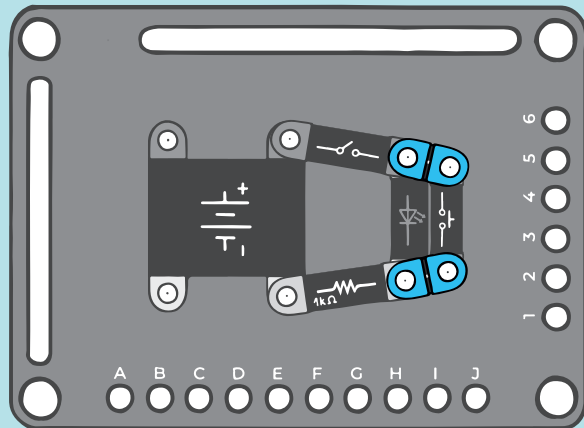

L180 POLARITY INDICATOR

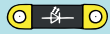

2x LED



1x resistor 1kΩ

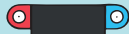

1x battery



3x



1x switch

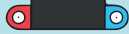

1x battery

Two anti-parallel LEDs indicate the polarity of the power supply. The LEDs light up alternately depending on the battery orientation. Try connecting the battery the other way – you will see that the second LED lights up.

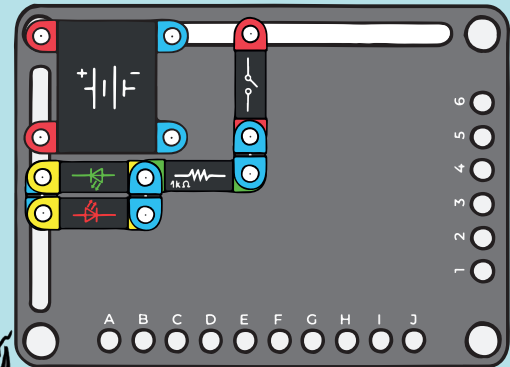

L190 HOW A SEMICONDUCTOR DIODE WORKS IN THE FORWARD DIRECTION



1x bulb



1x diode

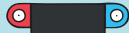

1x battery



1x

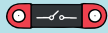

1x switch

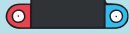

1x battery



1x

Insert a semiconductor diode into the basic circuit with a switch and a light bulb. The bulb only lights up when the switch is closed and the diode is oriented in the forward direction.

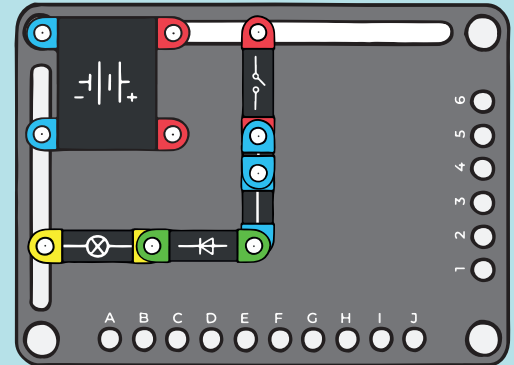

L200 HOW A SEMICONDUCTOR DIODE WORKS IN THE REVERSE DIRECTION



1x bulb



1x diode

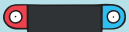

1x battery



1x



1x switch

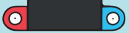

1x battery



1x

If the diode is oriented in the reverse direction, no electric current can flow through the circuit and the bulb cannot light up even when the switch is closed.

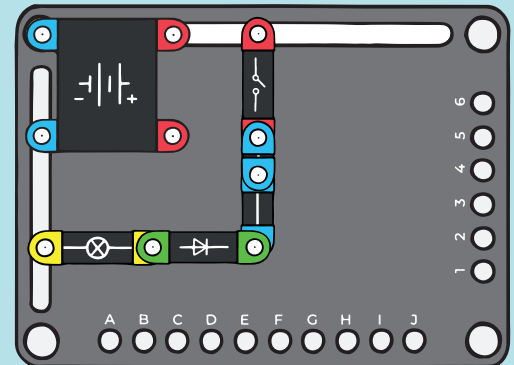

L210 CHANGING BRIGHTNESS SMOOTHLY I.

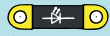

2x LED

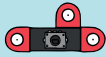

1x potentiometer

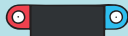

1x battery



1x



1x resistor 1kΩ



1x



1x

If you want to change the LED current continuously and without step changes, you can use a variable resistor, also called a potentiometer, for which the resistance corresponds to the angle of rotation of the small shaft. Structurally, it is a fixed resistor that has an exposed resistance layer, along which the collector travels; by turning the slider you select how much of the resistance path will be included in the circuit. When being turned, it moves away from one end (the resistance of this end increases). Due to the shaft rotation, the brightness „spills“ from one LED to the other as the resistance decreases on one side and increases on the other.

1.

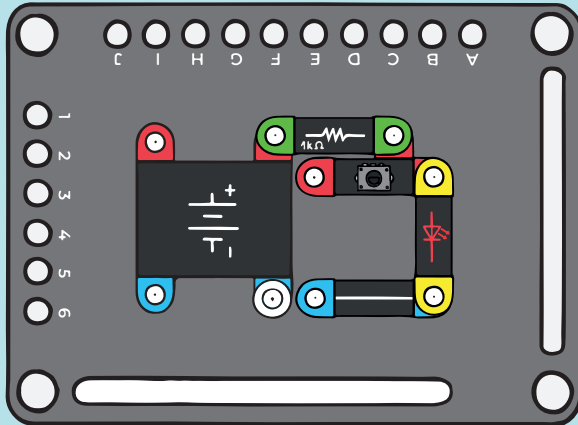

2.

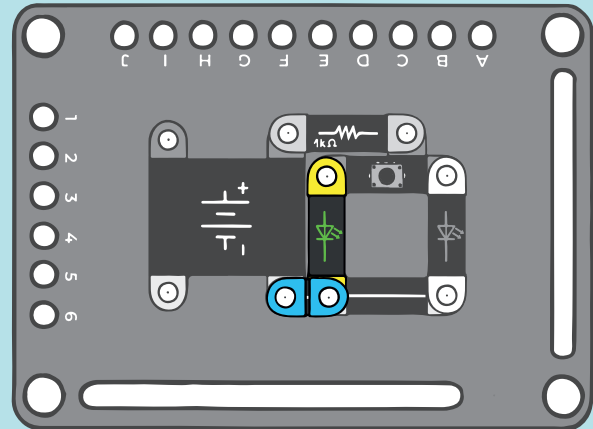





L220 SMOOTH BRIGHTNESS CHANGE II.

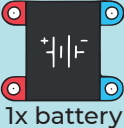

- 

1x switch
- 

1x potentiometer
- 

1x battery
-  4x
  3x
- 

2x LED
- 

1x resistor 1kΩ
-  2x
-  3x

Two LEDs in series with a potentiometer connected in parallel. Use the slider to set the voltage between the LEDs. The build behaves visually as L210, but now you do not control the current through the LEDs but, instead, control the current flow indirectly - by changing the voltage on the LEDs.

1.

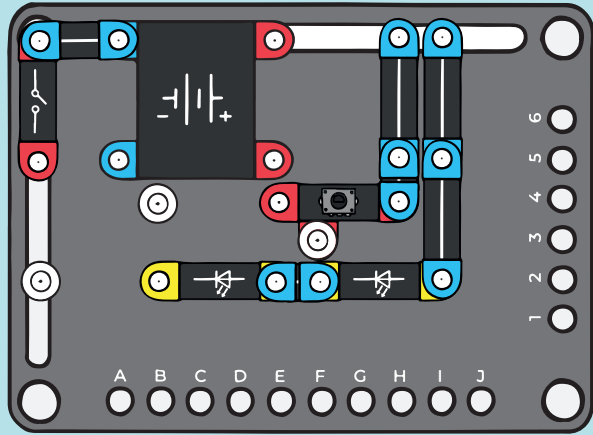

2.

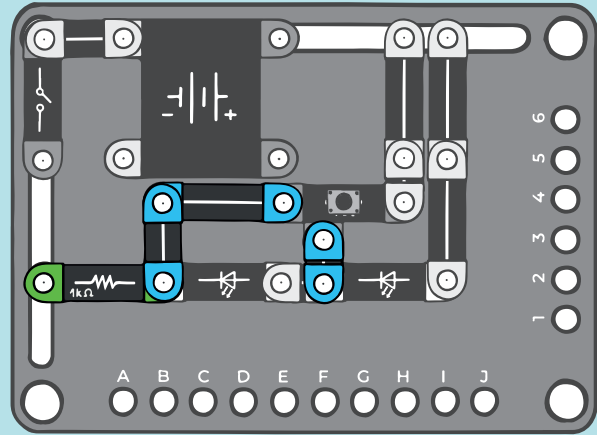

L230 CONDUCTIVITY DETECTOR I.

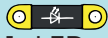

1x LED



1x resistor 1kΩ

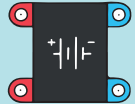

1x battery



1x



3x



1x paper clip

Connect the circuit as shown on the right so that you can test how different objects conduct or do not conduct electricity. For example, you can try to find a metal paper clip or teaspoon and place it on the contacts. If the object is conductive, the circuit will be closed and the LED will light up. In this case, the object has a similar function like a switch.

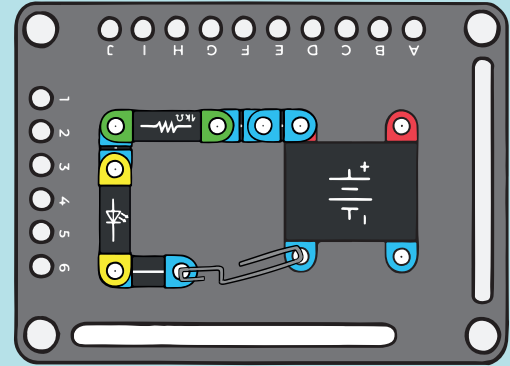

L240 HUMAN BODY CONDUCTIVITY DETECTOR

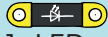

1x LED



1x resistor 1kΩ

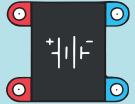

1x battery



1x



3x

You can use a simple electrical circuit to test the conductivity of your body. The human body is made up mostly of water; however, the human skin is dry and poses high resistance to electrical current. The resistance of the skin decreases when the skin is moist. A moist skin has such a low resistance that enough current flows through the circuit for the LED to give a dim light (this can be best demonstrated with the white LED).

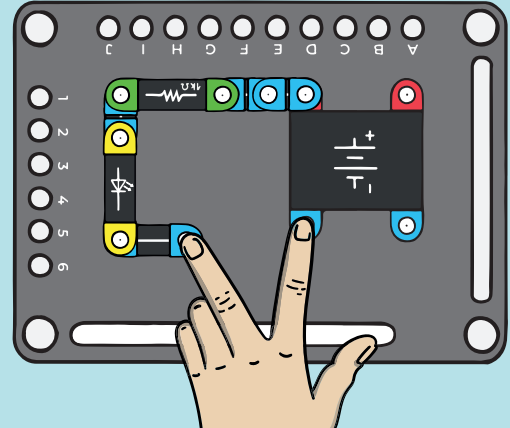

L250 CONDUCTIVITY DETECTOR II.

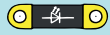

1x LED



1x resistor 1kΩ



banana

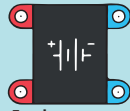

1x battery



3x



1x



1x

In addition to the human body, which has a high water content, you can test the conductivity of other water-containing things, such as various fruits and vegetables.

Warning: Never test the conductivity of an electrical network where a person could be injured!

Guess what has the highest conductivity?

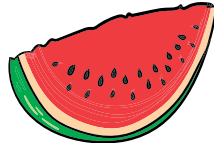

(Hint: You can eat almost anything with it - except maybe a bread roll.)

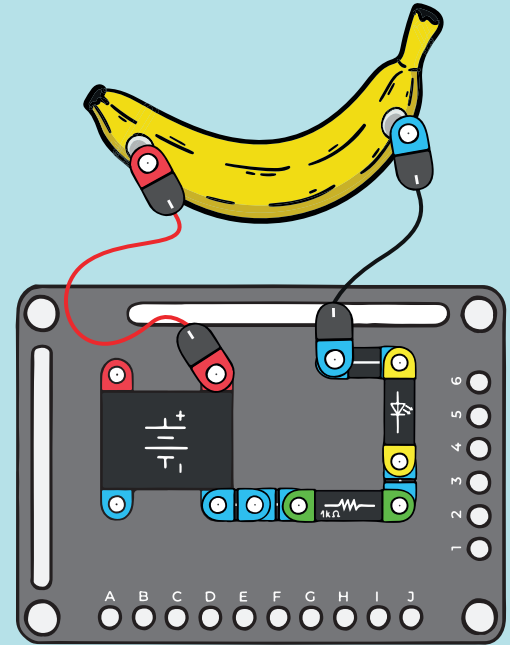

L260 WATER DETECTOR



1x LED



1x resistor 1kΩ



cup

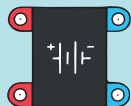

1x battery



1x



3x



1x



1x

Test that pure water, tea, or any other liquid is conductive enough to light up the LED in the circuit. Take conductive parts with magnets and connect them to kitchen utensils – you can test the conductivity of water.

Tip: Try testing other household items that conduct electricity, such as a banana, bread roll, etc.

Warning: Never test the conductivity of the mains as you could get injured!

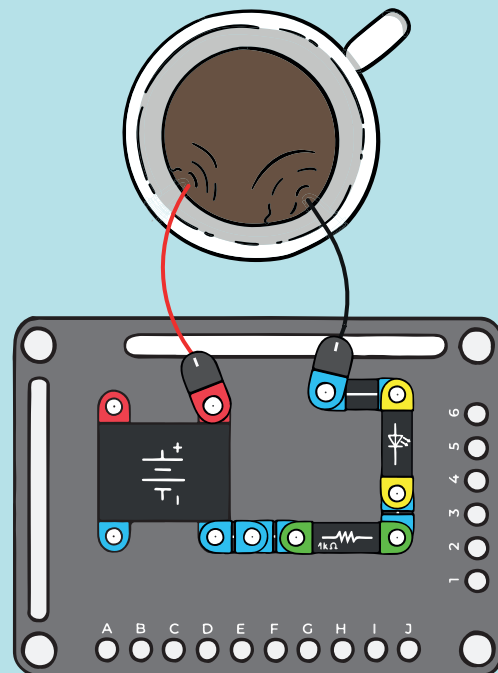

270 LIGHT ALARM

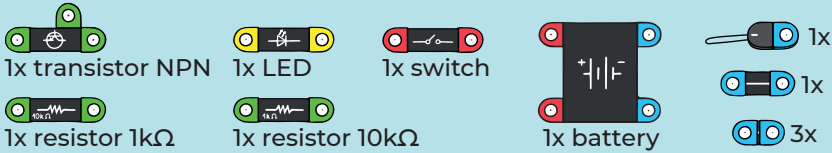

At rest, the base of the transistor is short-circuited by a conductor to ground. No current flows into the base and the transistor is closed. The LED is off. If the conductor is broken, the transistor opens because a current already flows into the base and the LED lights up.

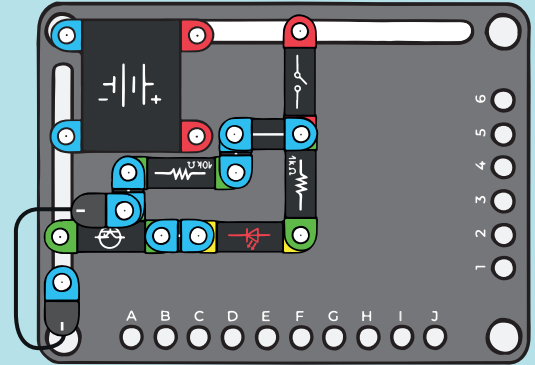



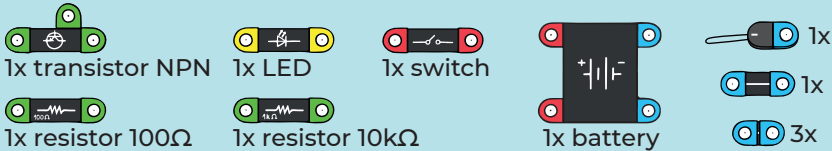

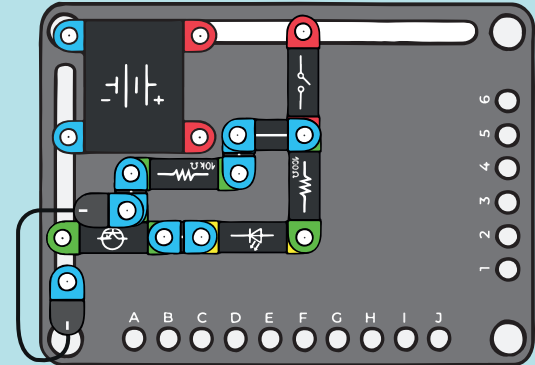

L280 INTENSIVE LIGHT ALARM

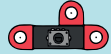
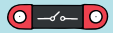
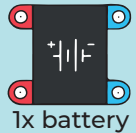
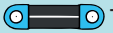

By replacing the LED with a white LED with a different resistance, you will obtain an intensive light alarm.



L290 NPN AMPLIFIER WITH LED

- 
 1x LED
- 
 1x potentiometer
- 
 1x switch
- 
 1x battery
-  1x
  2x
- 
 1x bulb
- 
 1x transistor NPN
- 
 1x resistor 1kΩ
-  1x
-  3x

The circuit demonstrates the ability of a transistor to amplify an electric current. Use a potentiometer to control the current flowing through a LED diode to the transistor base. A low current that is barely sufficient to turn on the LED will cause the transistor to open and cause a high current to flow through the bulb as the partial opening of the transistor will increase the voltage on the bulb. This build is called a common emitter circuit because the emitter of the transistor is connected to a common power supply.

1.

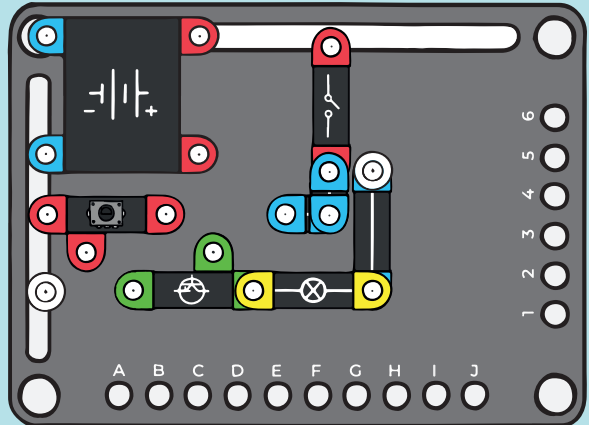

2.

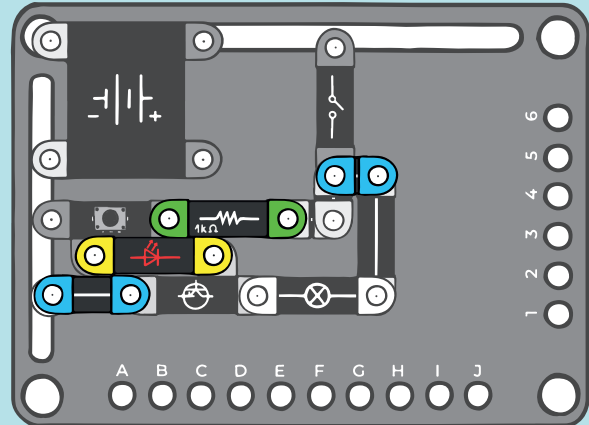

L300 NPN AMPLIFIER WITH LED IN REVERSE DIRECTION

- 
 1x LED
- 
 1x transistor NPN
- 
 1x potentiometer
- 
 1x battery
-  1x
-  2x
- 
 1x bulb
- 
 1x switch
- 
 1x resistor 1kΩ
-  1x
-  3x

This build uses the same circuit as the previous one, just with the LED connected in the reverse direction. Therefore, no current flows into the transistor base and the bulb does not give light.

1.

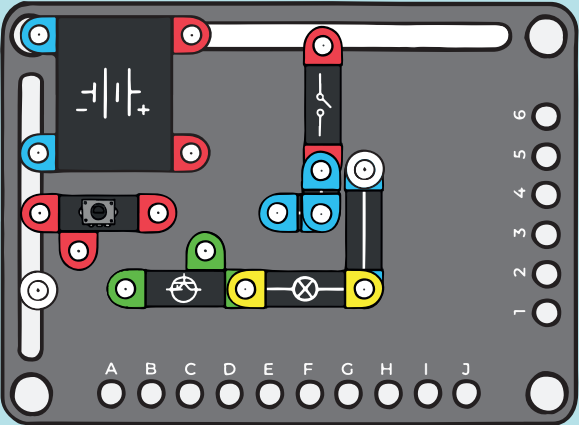

2.

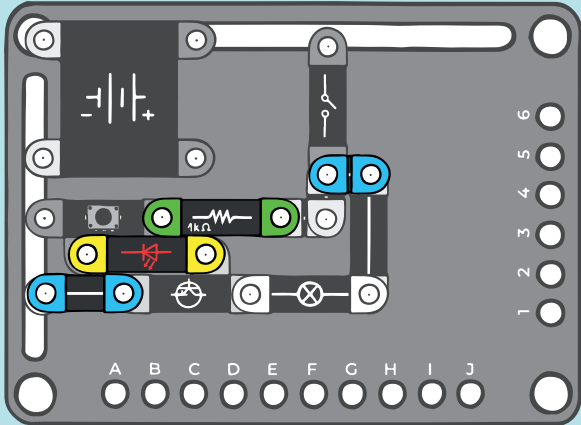

L310 AMPLIFIER WITH LED

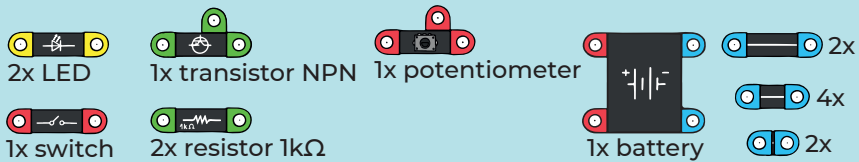

The circuit demonstrates the ability of a transistor to amplify an electric current. Use a potentiometer to control the current flowing through a LED diode to the transistor base. A low current that is barely sufficient to turn on the LED will cause the transistor to open to the extent that the voltage on the LED will be enough to light it up.

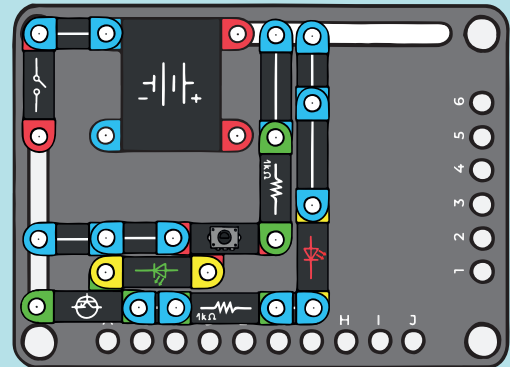

L320 SWITCHING WITH BUTTON II.

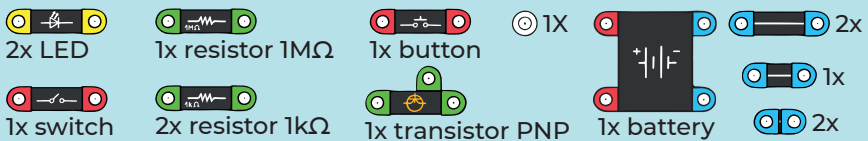

To switch between the red and the white LEDs, we used significantly different properties of both LEDs (different lighting voltages). However, if you want to switch similar or the same LEDs, you need to choose a different solution. You can use a PNP transistor. In this case, it acts as a switch that opens (and thus the corresponding LED goes out) if you press the button. At the same time, the button switches the second LED on, and it should light up when the button is pressed.

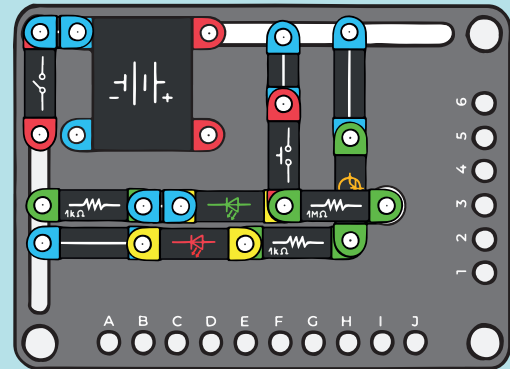

L330 ADJUSTABLE POWER SWITCH

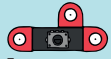

1x potentiometer



1x A/B switch

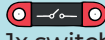

1x switch



1x battery



4x



3x



1x



1x resistor 1kΩ

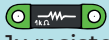

1x resistor 100Ω



1x LED

By combining a switch and a potentiometer, you can build a circuit where the switch can be used to select a constant brightness, or continuous LED brightness control with a potentiometer.

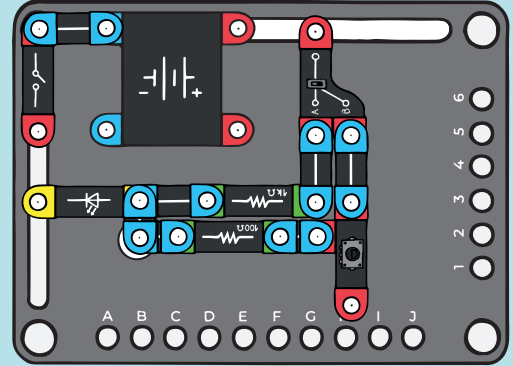

L340 SAFETY BUTTON

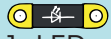

1x LED



1x resistor 1kΩ

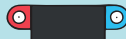

1x battery



1x



2x button

Two buttons connected in series close the circuit only if both buttons are pressed. The circuit closure is indicated by the LED. In practice, this connection is used as a safety element for dangerous machines (e.g. when material needs to be loaded manually under a press) where the operator must press two buttons with both hands to activate the machine. This ensures that both hands are out of the dangerous parts of the machine, which prevents injuries.

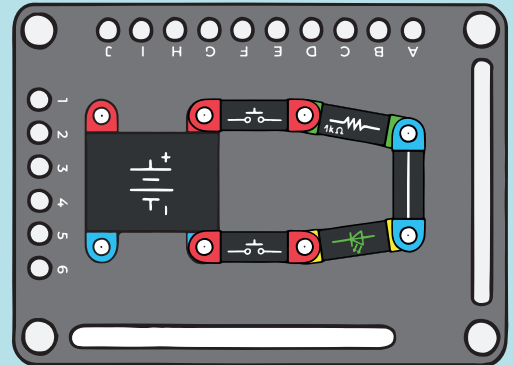

L350 CARBON BUTTON

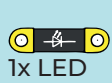

1x LED



1x transistor NPN

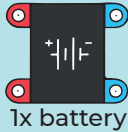

1x battery



1x



1x



2x resistor 1kΩ



1x switch



2x



1x



paper and pencil

You can create a button using a graphite painting - a set of two separate conductive parts that you connect with the touch of a finger. As in the case of the carbon potentiometer, the current flow through the button is very small, so it is advisable to amplify it with a transistor. This graphic representation of the button is actually used in practice. For example, calculators or remote controls have the same pattern etched on a printed circuit board, and the conductive traces are connected by a graphite layer on the underside of a rubber button. It is a very simple and working solution that does not require separate buttons as additional components.

1.

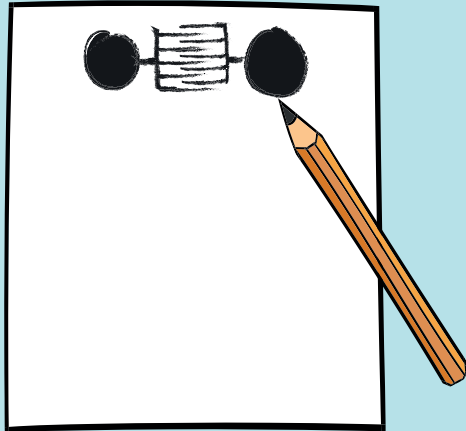

2.

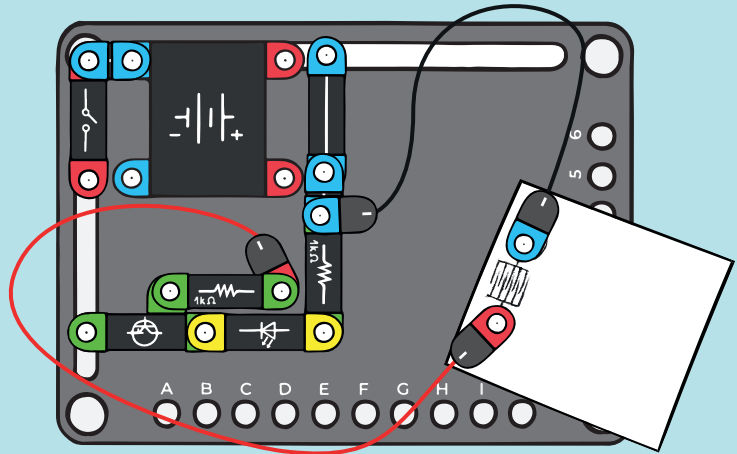

L360 CARBON POTENTIOMETER

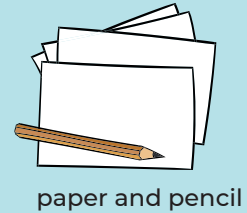
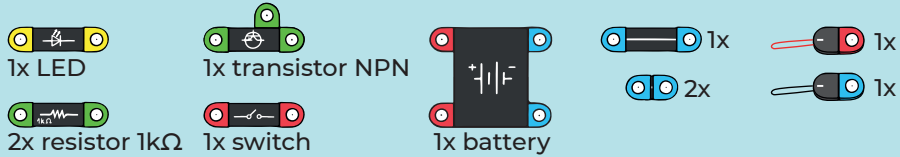

The material from which the resistance layer of the potentiometer is made is graphite. It is the same material that forms the ordinary pencil lead. If you draw a thick line on paper with a pencil, a resistance path is created that you can then connect to the conductors in the circuit. The longer the line, the higher the resistance at its ends. The thicker the line, the less resistance there is. Since the resistance value may be too high to turn on the LED directly, we will use a transistor in connection with a common emitter, where we will use the voltage gain to light up the LED. If you fasten one conductive component firmly to one edge of the line and move the other, you will get a variable resistance, i.e. a potentiometer.

1.

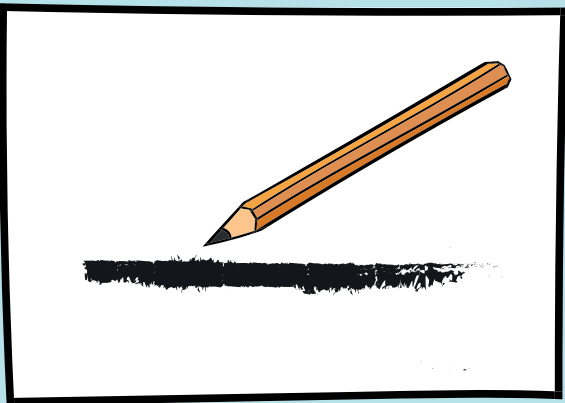

2.

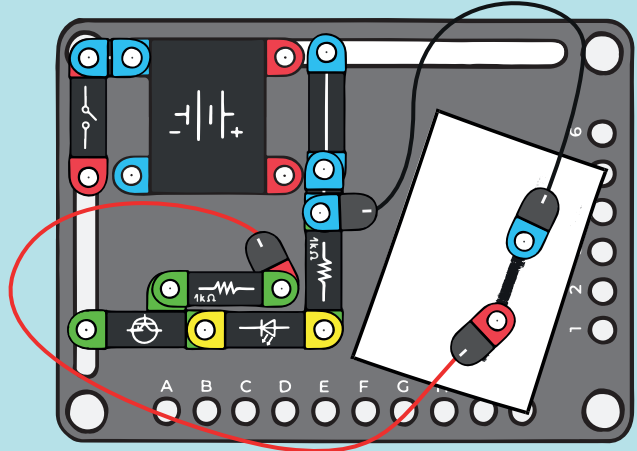

L370 CE PNP AMPLIFIER WITH A LED AND BULB

- 1x LED
- 1x switch
- 1x resistor 1kΩ
- 1x battery
- 1x bulb
- 1x transistor PNP
- 1x potentiometer
- 3x
- 1x

Functionally, it is the same circuit as the NPN amplifier with LED (page 40), just with a transistor of opposite conductivity. The base current flows in the opposite direction; therefore, it is necessary to modify the base circuit accordingly.



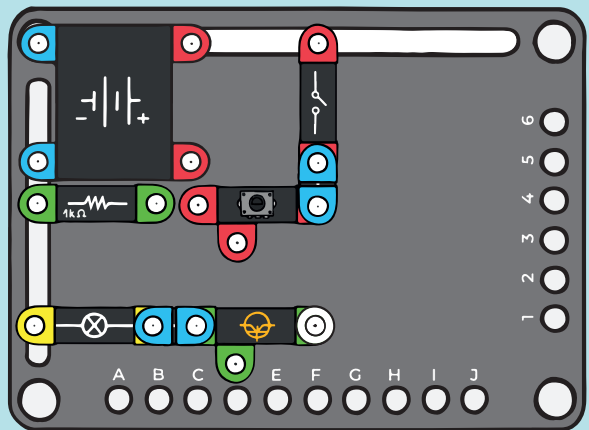



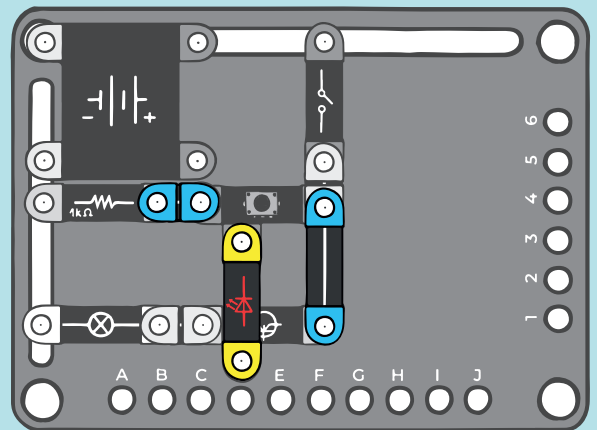

1.

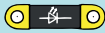

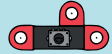
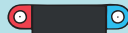
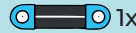
2.



L380 PNP AMPLIFIER WITH LED IN REVERSE DIRECTION

- 
 1x LED
- 
 1x transistor PNP
- 
 1x potentiometer
- 
 1x battery
- 
 1x
- 
 1x bulb
- 
 1x switch
- 
 1x resistor 1kΩ
- 
 3x
- 
 1x

Use a potentiometer to control the current flowing through a LED diode to the transistor base. However, the LED is in the reverse direction, and so no current flows through the base and there is nothing to amplify. The bulb cannot light up because the transistor is closed.

1.

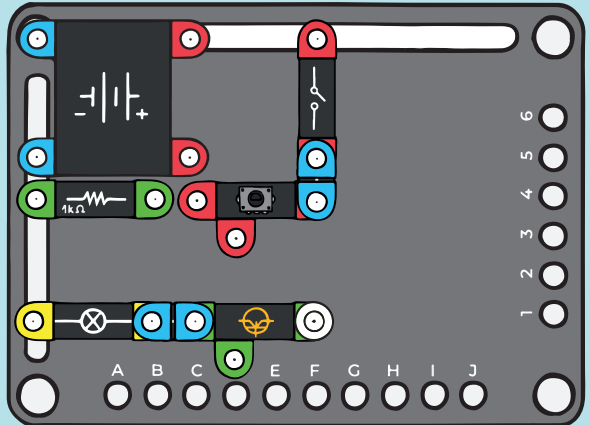

2.

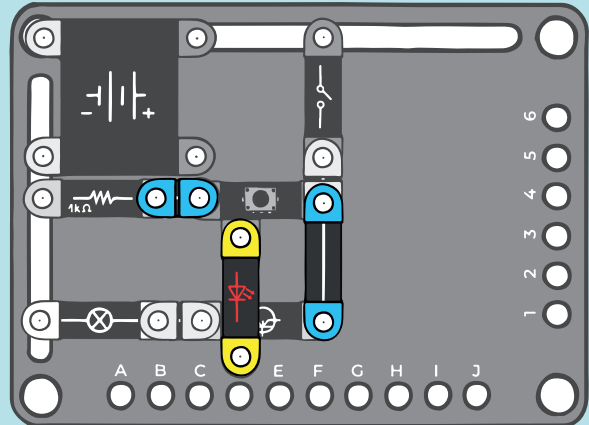

L390 EMITTER FOLLOWER WITH NPN

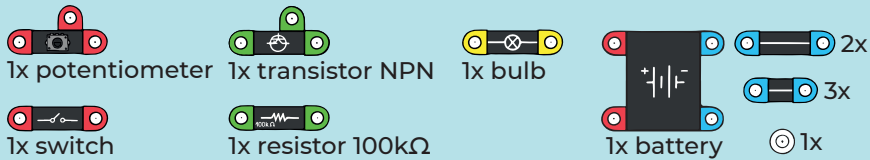

This build basically replicates the connection of the potentiometer slider directly to the bulb against the ground. However, too much current would flow through the potentiometer and destroy it. Therefore, we use a component called 'emitter follower' (connected with a common collector). It copies the voltage at the potentiometer output, but the transistor takes over the actual current load. Only a very small current flows through the potentiometer without the risk of damaging it.

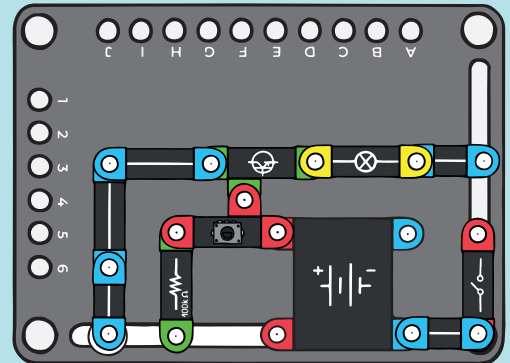

L400 CE AMPLIFIER WITH NPN AND LEDs

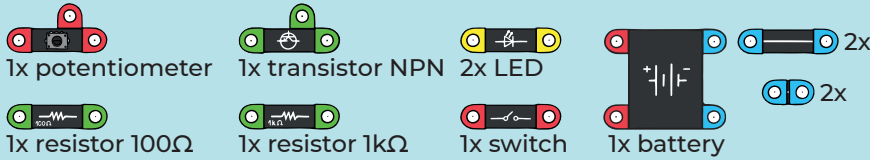

The circuit demonstrates the ability of a transistor to amplify an electric current. Use a potentiometer to control the current flowing through a LED diode to the transistor base. A low current that is barely sufficient to turn on the LED will cause the transistor to open to the extent that the voltage on the LED is sufficient to light it up.

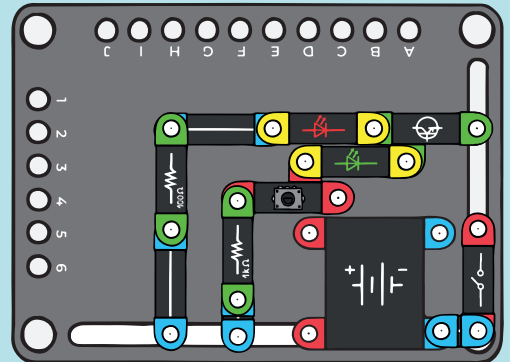

L410 CE AMPLIFIER WITH PNP AND BULB

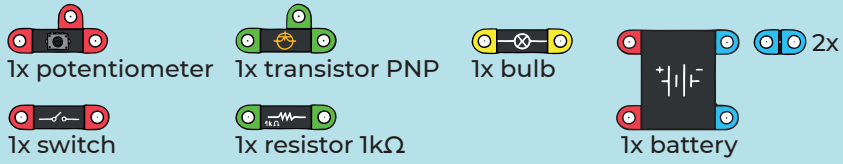

By changing the low current to the transistor base, you can control the high current flowing through the bulb since opening and closing the transistor causes the voltage on the bulb to change. We use a PNP transistor in this case.

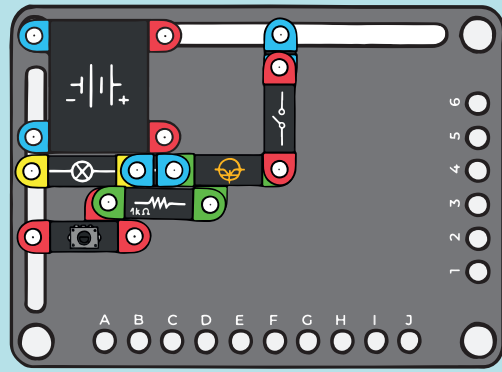

L420 EMITTER FOLLOWER WITH PNP

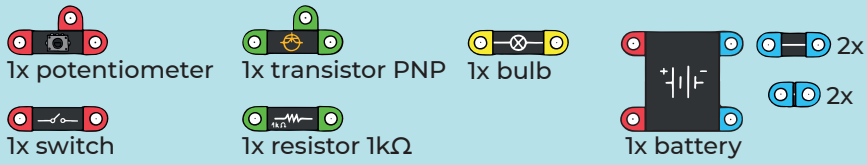

Functionally, it is the same circuit as the emitter follower with NPN, just with a transistor of opposite conductivity. The base current flows in the opposite direction; therefore, it is necessary to modify the base circuit accordingly.

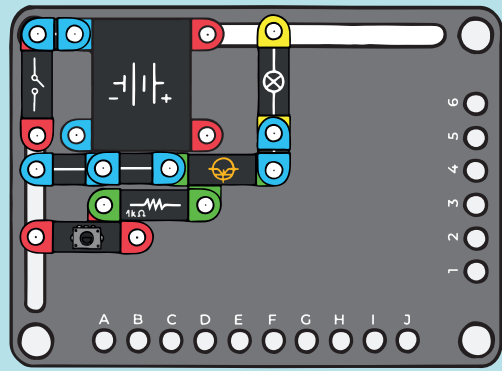

L430 RAISING CURRENT BY BASE WITH CC AMPLIFIER WITH PNP

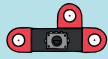

1x potentiometer



1x transistor PNP



1x bulb

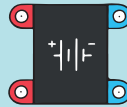

1x battery



2x



2x



1x switch



1x resistor 100Ω

Changing the base resistor to a low value of 100 Ω will increase the current flowing to the transistor base, but the bulb brightness remains almost constant. This is because the voltage on the bulb still corresponds to that on the potentiometer slider although the circuit would be able to supply more current. However, since the load is still just one bulb, the amount of current consumed does not increase, so changing the resistor has virtually no effect.

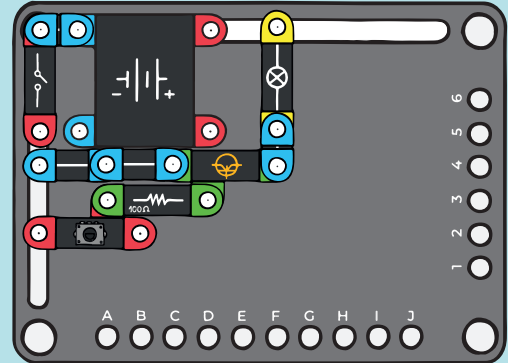

L440 CE AMPLIFIER WITH NPN AND BULB

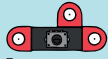

1x potentiometer



1x transistor NPN



1x bulb

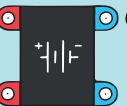

1x battery



1x



3x



2x

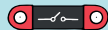

1x switch



1x resistor 10kΩ



1x

By changing the low current to the transistor base, you can control the high current flowing through the bulb since opening and closing the transistor causes the voltage on the bulb to change. We use an NPN transistor in this case.

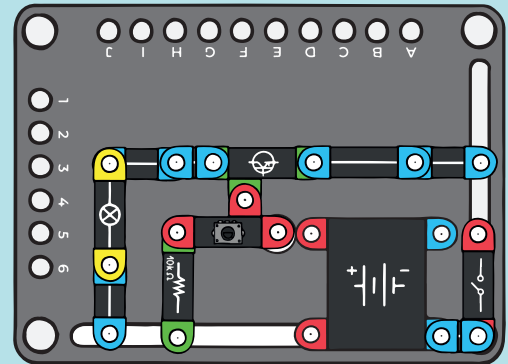

L450 BRIGHTNESS CONTROL



With the potentiometer you can directly control the current flowing through the LED diode and thus change its brightness. A small resistor in series serves as a current limiter when the potentiometer is set to the extreme position where it has zero resistance.

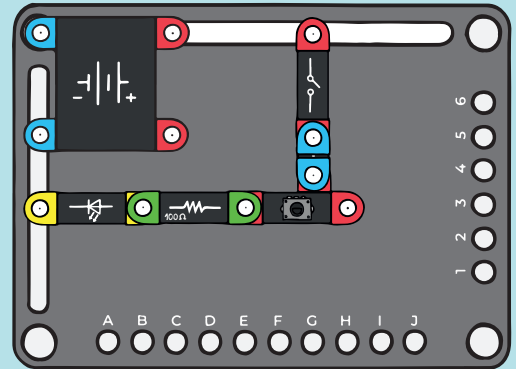



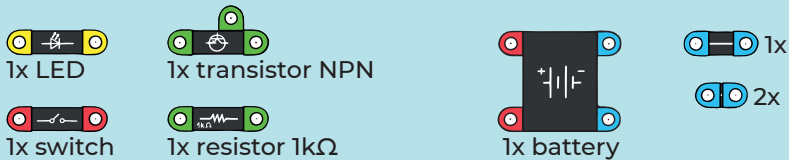



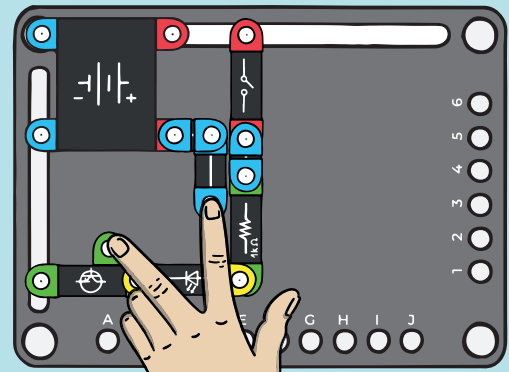

L460 TWO-FINGER TOUCH LAMP

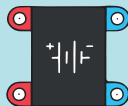

In addition to the graphite potentiometer, you can use your own fingers to turn on the transistor. Just touch the base terminal with one finger and the power supply contact with the other finger. For NPN it is the positive contact of the power supply, for PNP it is the negative contact. A very low current flows through the hand, which is then amplified by the transistor to a value that is enough to light up the LED diode.

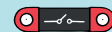

L470 CONTROLLING NPN TRANSISTOR BY LIGHT I.

- 
 1x bulb
- 
 1x transistor NPN
- 
 1x battery
- 
 1x fotoresistor
- 
 1x switch
- 
 1x
- 
 2x
- 
 1x

The more the photoresistor is illuminated, the more light the bulb emits since the transistor opens. The build is functionally the same as L90 however, a direct series combination of a photoresistor and bulb would have such a high resistance that the bulb would not light up on battery power, so we will use the transistor as a voltage amplifier for the bulb.



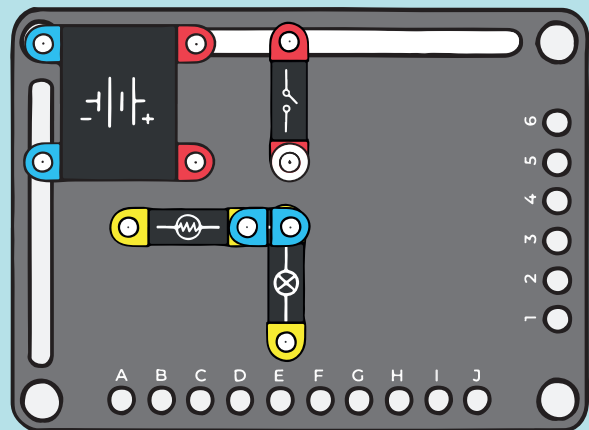



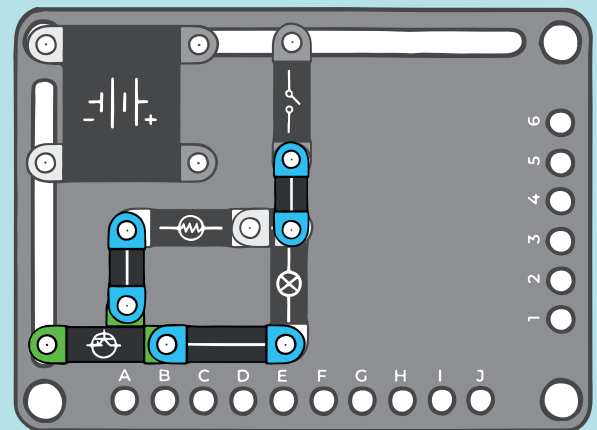

1.

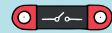

2.

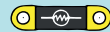

L480 CONTROLLING NPN TRANSISTOR BY LIGHT II.

- 
 1x bulb
- 
 1x transistor NPN
- 
 1x switch
- 
 1x battery
-  2x
-  2x
- 
 1x fotoresistor
- 
 1x resistor 10kΩ
-  4x

The photoresistor together with the resistor form a voltage divider, the output voltage of which depends inversely on the degree of illumination. The less the photoresistor is illuminated, the more the transistor opens, the voltage on the bulb and the current through the bulb increase until the bulb lights up. When illuminated, the current to the transistor base drops and the bulb goes out as the transistor closes.



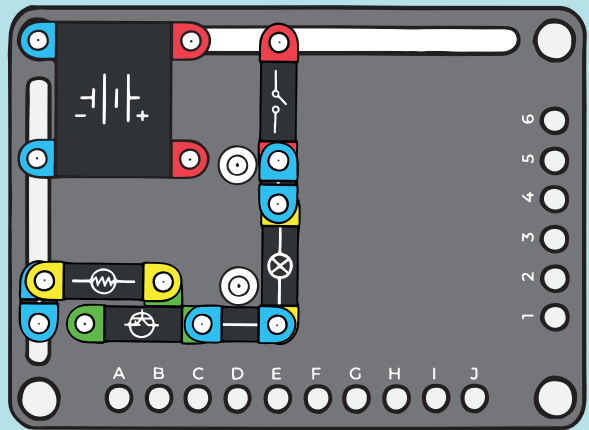

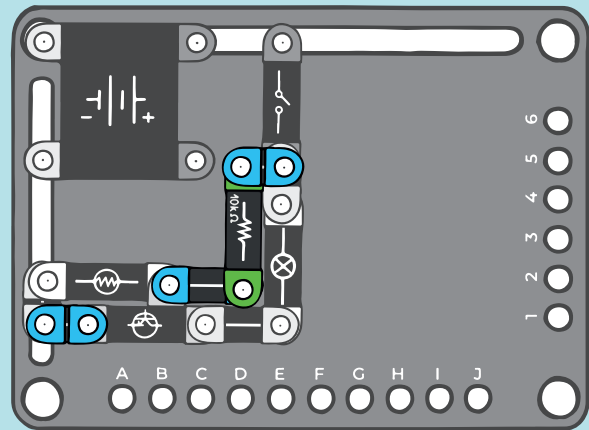

1.



2.



L490 CONTROLLING PNP TRANSISTOR BY LIGHT I.

- 
 1x bulb
- 
 1x transistor PNP
- 
 1x battery
- 
 2x
- 
 1x fotoresistor
- 
 1x switch
- 
 2x

Functionally, this is the same build as L470, but with a transistor of opposite conductivity. The direction of the base current is opposite, so it is necessary to modify the base circuit. The bulb is connected in the emitter circuit (see L440), so the bulb reacts with lower brightness because the voltage on the bulb is low as it copies the voltage on the photoresistor.

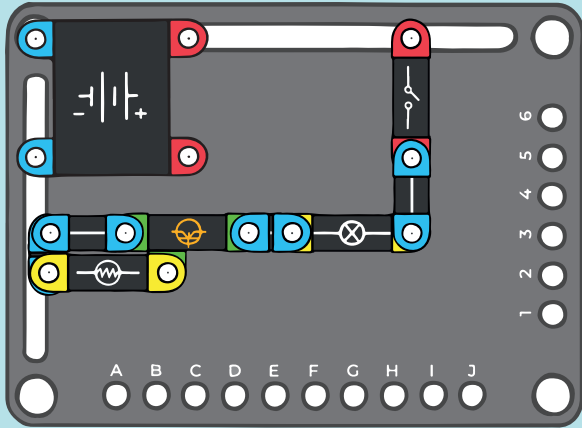

L500 CONTROLLING PNP TRANSISTOR BY LIGHT II.

- 

1x bulb
- 

1x transistor PNP
- 

1x resistor 1kΩ
- 

1x battery
- 

1x fotoresistor
- 

1x switch
- 

1x
- 

2x
- 

5x
- 

2x

Functionally, this is the same build as L480 but with a transistor of opposite conductivity. The direction of the base current is opposite, so it is necessary to modify the base circuit. The bulb lights up again when the photoresistor is darkened, but because it is again connected in the emitter circuit, the voltage on the bulb is low and the bulb responds with lower brightness.

1.

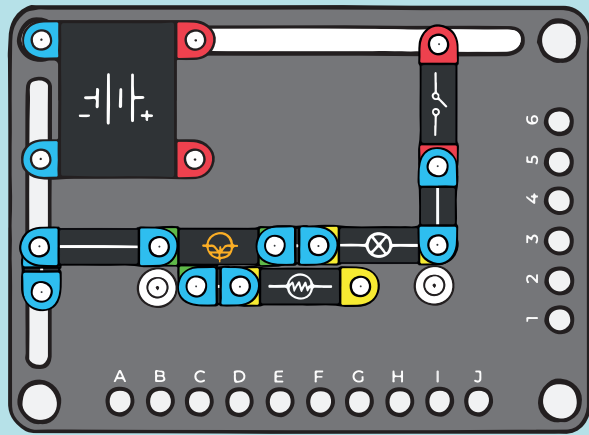

2.

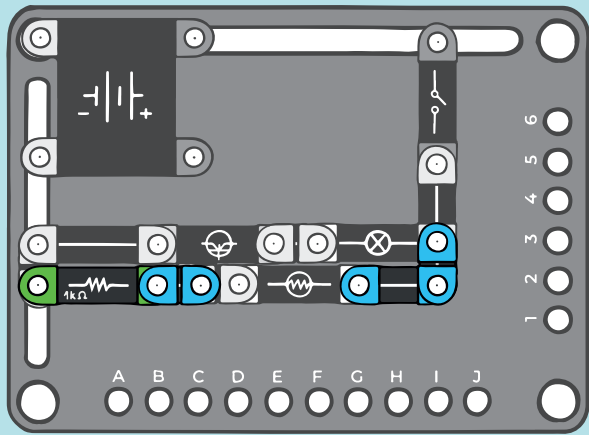

L510 STANDARD TRANSISTOR CIRCUIT

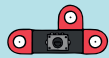

1x potentiometer



1x transistor NPN



2x resistor 1kΩ

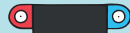

1x battery



1x 2x



1x LED



1x switch



1x resistor 10kΩ



5x



2x

We use a potentiometer to control the current flowing to the base, which changes the current flowing through the collector and, thus, also changes the LED brightness because the voltage on the LED changes. The resistance in the transistor emitter introduces a weak feedback, thus limiting the range of brightness control options.



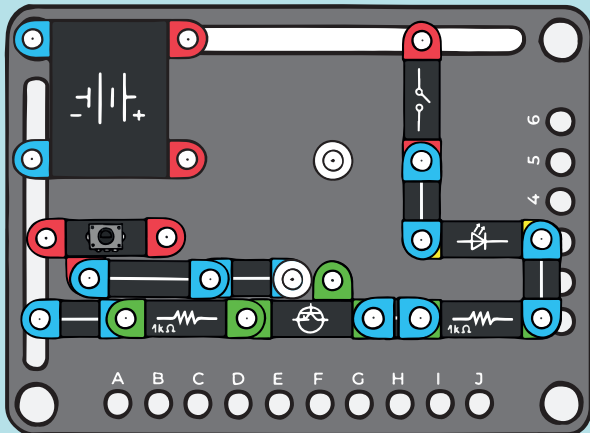

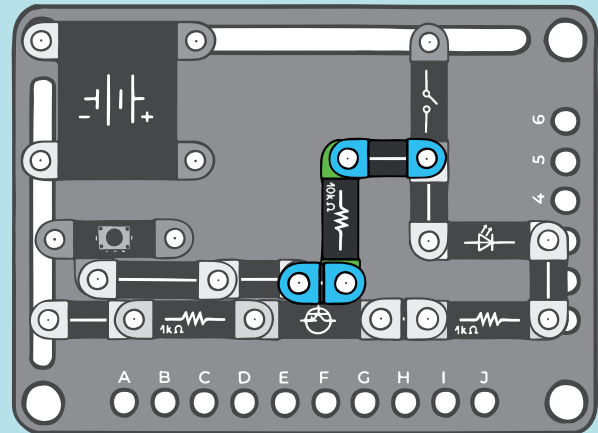

1.



2.

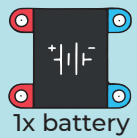

● L520 FLASHING LIGHT BULB

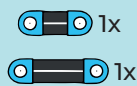
- 
 1x bulb
- 
 1x transistor NPN
- 
 1x transistor PNP
- 
 1x battery
- 
 1x resistor 1MΩ
- 
 1x resistor 100Ω
- 
 1x capacitor 10μF
- 
 1x
- 
 3x

An astable flip-flop can also be built using two amplifiers consisting of transistors of opposite conductivity. The build is simplified a bit, but the stability of the circuit is worse. The bulb is switched directly by the amplifier with a PNP transistor, so the bulb flashes with high brightness. The blinking is short with long pauses, so it may take a while for the bulb to light up for the first time after you connect the battery.

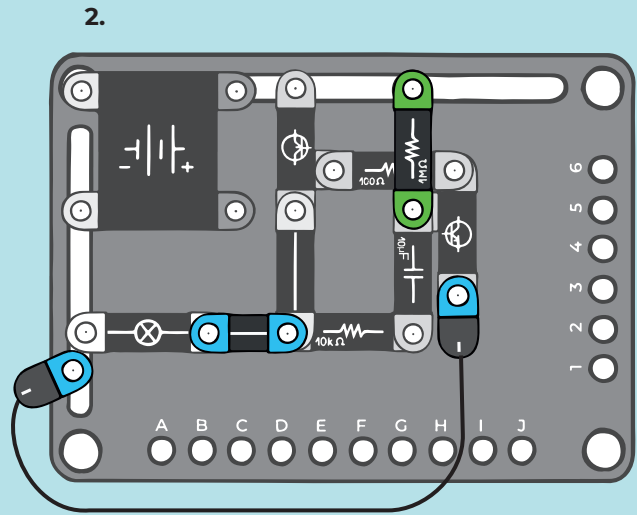
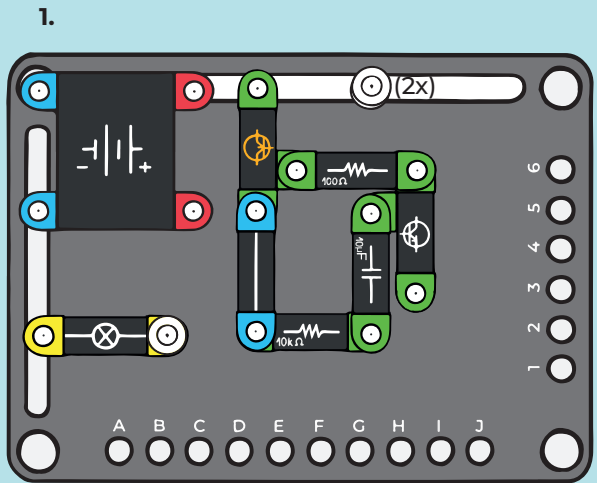

L530 NIGHT LIGHT AUTOMATIC SWITCH-OFF I.



1x transistor NPN

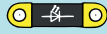

1x LED



1x resistor 1kΩ

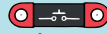

1x button

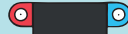

1x battery



2x 3x



1x



5x

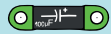

1x capacitor 100µF



1x switch



1x resistor 100kΩ

When the switch is turned in the ON position, the capacitor starts charging. As the capacitor charges, the current flowing through it decreases. This also closes the transistor and the LED slowly dims until it goes out. Press the button to discharge the capacitor and the LED will light up again and slowly dim until the capacitor is fully charged again.

1.

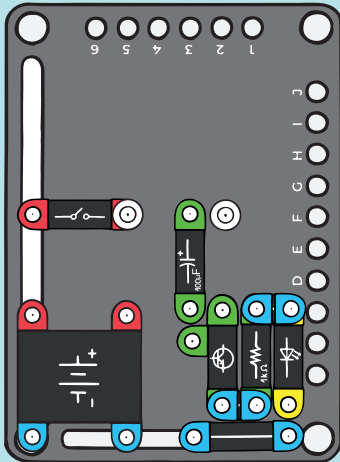

2.

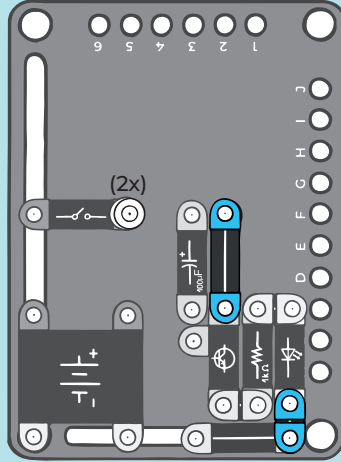

3.

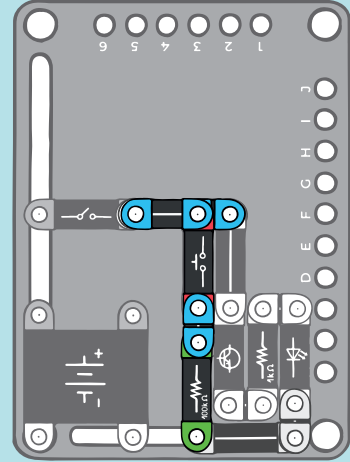

L540 NIGHT LIGHT AUTOMATIC SWITCH-OFF II.



1x transistor NPN



1x LED



1x resistor 1kΩ



1x button



1x battery

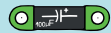
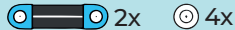

2x capacitor 100µF



1x switch



1x resistor 100kΩ

The light dimming time can be extended by adding another capacitor in parallel with the previous one. The parallel arrangement of the capacitors adds up their capacitances, so it will take longer for the capacitor to charge and for the LED to go out.

1. step 2 of L530

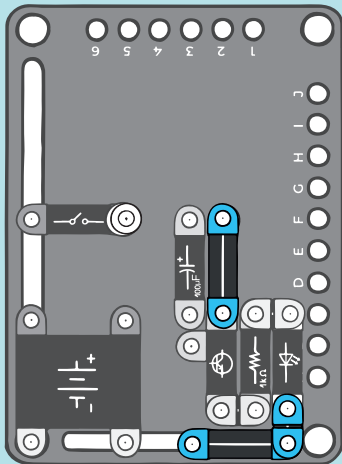

2.

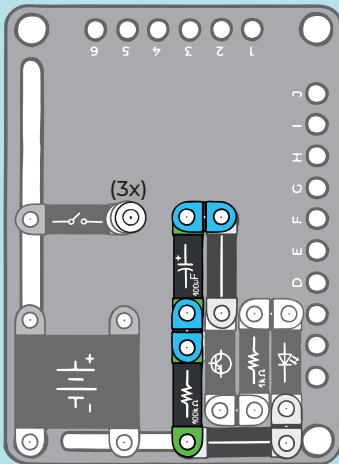

3.

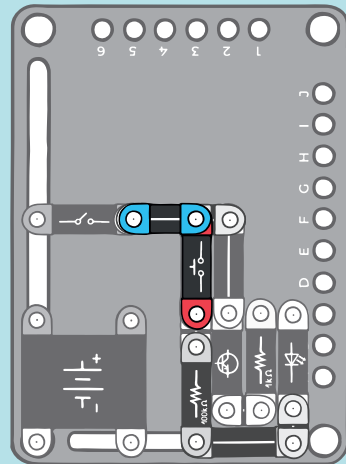

L550 NIGHT LIGHT AUTOMATIC SWITCH-OFF III.



1x transistor NPN



1x LED



1x resistor 1kΩ

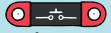

1x button



1x battery



2x



4x

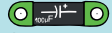

2x capacitor 100uF

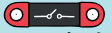

1x switch



1x resistor 10kΩ



1x



5x

You can also shorten the lighting time. You can use a capacitor with a smaller capacitance, but a more practical variant is to replace the resistor between the transistor base and the ground with a smaller one. This will increase the charging current of the capacitor, and the capacitor will charge faster. The current flowing to the transistor base will then stop sooner – the transistor will close and the LED go out.

1. step 2 of L530

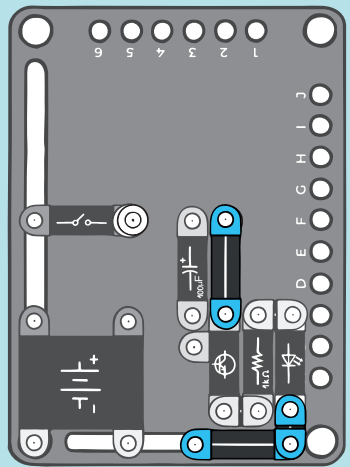



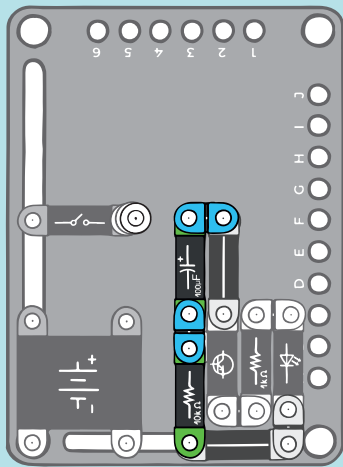



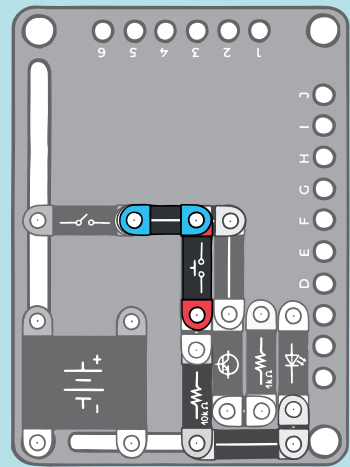

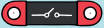

2.



3.



L560 SCHMITT CIRCUIT

- 
 1x switch
- 
 1x potentiometer
- 
 2x transistor NPN
- 
 1x battery
- 
 1x LED
- 
 2x resistor 1kΩ
- 
 1x resistor 100Ω
- 
 1x
- 
 4x
- 
 5x
- 
 4x

A special type of two-stage amplifier. Unlike simple amplifiers that allowed the LED brightness to be adjusted continuously using the potentiometer, here the brightness changes in steps. By turning the potentiometer, you can only turn the LED on or off. The continuous change of voltage at the input of the circuit is thus converted to a simple on or off of the electric current, which is indicated by the LED. The reason is the introduction of feedback, which allows only one transistor to be opened and prevents a gradual change of state by preventing the change „until the last minute“ (the circuit does not respond to the rotation of the potentiometer by gradually changing the brightness of the LED). If the coupling can no longer prevent the flipping, it at least speeds up the flipping so that the change of state is essentially instantaneous. The circuit is used as a signal shaper or as a detector of a certain voltage limit.

1.

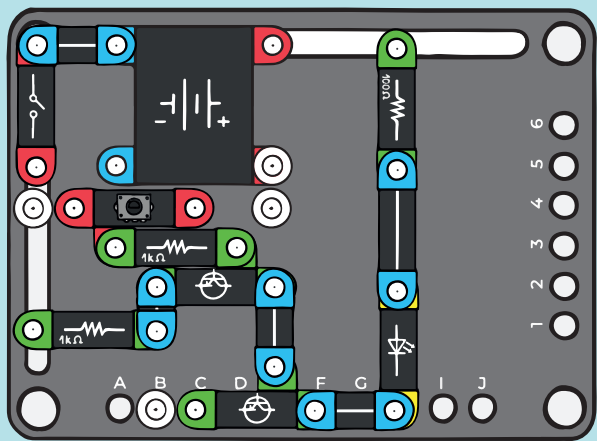

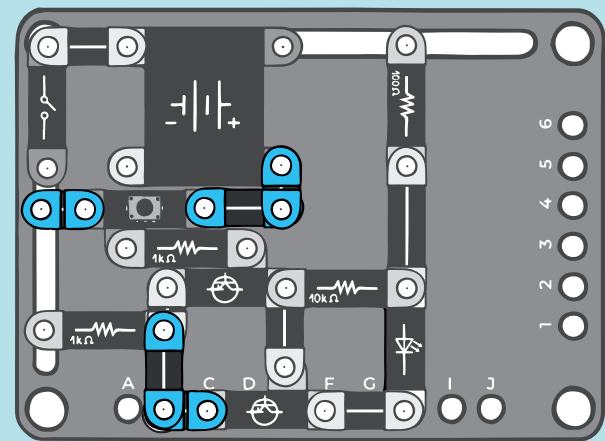

2.





L570 NIGHT LIGHT AUTOMATIC SWITCH-OFF IV.

- 

1x bulb
- 

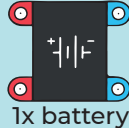
1x transistor PNP
- 

2x transistor NPN
- 





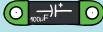

1x battery
- 

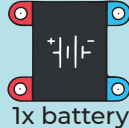
1x button
- 

2x resistor 10kΩ
- 

1x resistor 100Ω
- 

1x capacitor 100uF
- 

1x battery
-  1x
-  2x
-  1x
-  2x
-  4x
-  1x

With the Schmitt circuit, you can improve the familiar switching off of the night light, which has the disadvantage that switch-off is not abrupt – the brightness slowly fades. The Schmitt circuit solves this with its step change, causing the light bulb to be either fully lit up or go out. Due to the connection method, the capacitor charging function is reversed. In the original instructions, the light went out when the capacitor was fully charged, and we then discharged it by pressing the button. Now, you can charge the capacitor by pressing the button and then let it gradually discharge. You can also improve the circuit with a transistor amplifier with a PNP transistor, which amplifies the output of the Schmitt circuit so much that we can use a light bulb instead of a LED diode.

1.

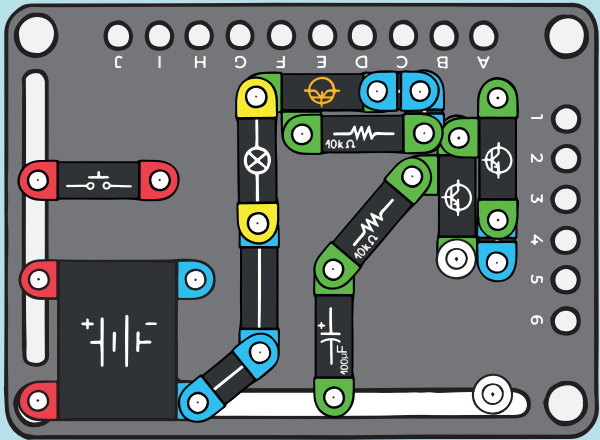

2.

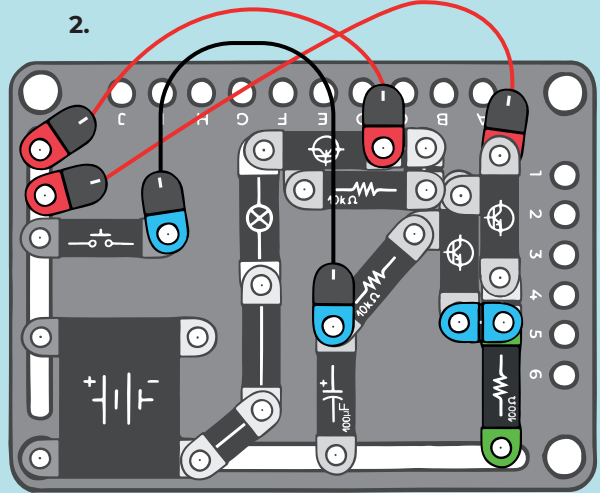

L580 NIGHT LIGHT AUTOMATIC SWITCH-OFF V.

- 1x bulb
- 1x transistor PNP
- 1x transistor NPN
- 1x battery
- 1x button
- 1x capacitor 100uF
- 1x resistor 10kΩ
- 3x push button
- 1x toggle switch
- 5x jumper
- 3x LED
- 1x potentiometer

A simplified version without the Schmitt circuit. The circuit works similarly to L570 however, in the absence of a Schmitt circuit, it causes an undesirably slow dimming of the light.

1.

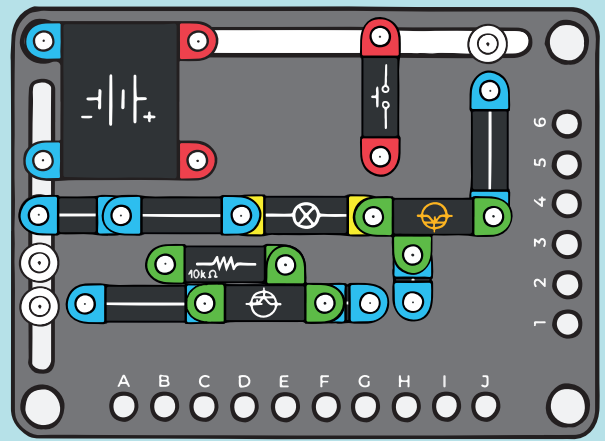

2.

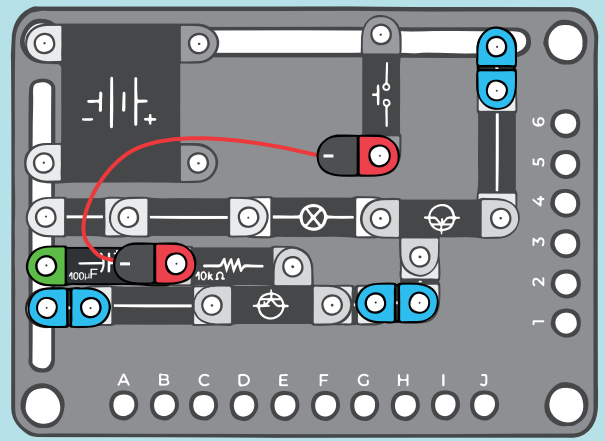

L590 RAIL CROSSING



2x transistor NPN

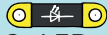

2x LED

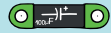

2x capacitor 100uF



2x resistor 10kΩ

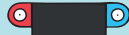

1x battery



2x



2x



4x



1x

If you connect two separate transistor amplifiers in series and connect the output again to the input, we get an astable flip-flop. This circuit has no stable state and constantly flips. Similar to L530 the transistor opening time is determined by the charging of the capacitor, with the difference being that the capacitor does not remain charged but begins to discharge again. The result is a constant alternating opening of both transistors, which is signaled by the alternating light of both LEDs. By choosing suitable sizes of resistors and capacitors, you can achieve the illusion of rail crossing signaling.

1.

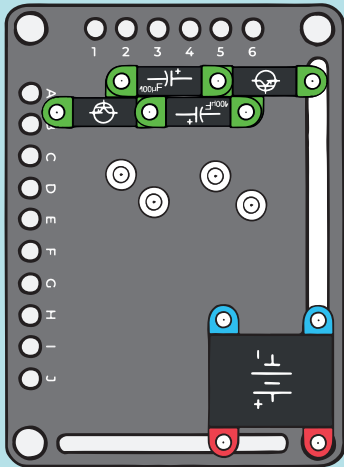

2.

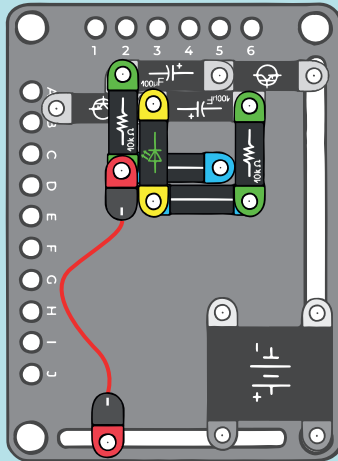

3.

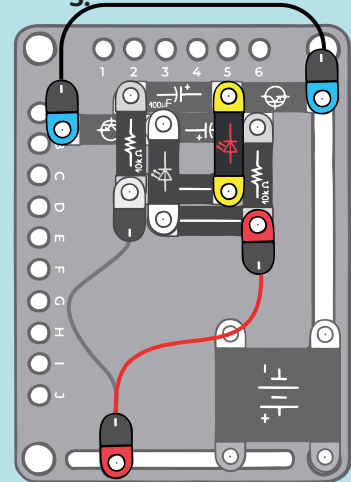

L600 TWILIGHT SWITCH

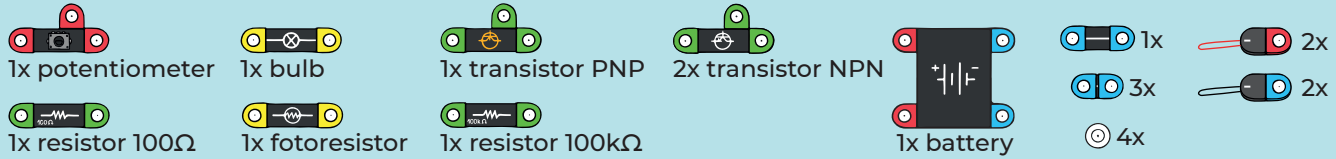

You can also use the Schmitt circuit to detect darkness. A voltage divider of the resistor and the photoresistor evaluates the Schmitt circuit, which turns on the bulb through the PNP transistor. If the photoresistor is well lit, the bulb will not light up. If it is shaded, the bulb lights up in full brightness thanks to the Schmitt circuit, and its brightness does not depend on the level of illumination as is the case in the following builds: L480 and L500. The level of shading when the bulb is to light up can be set with a potentiometer.

1.

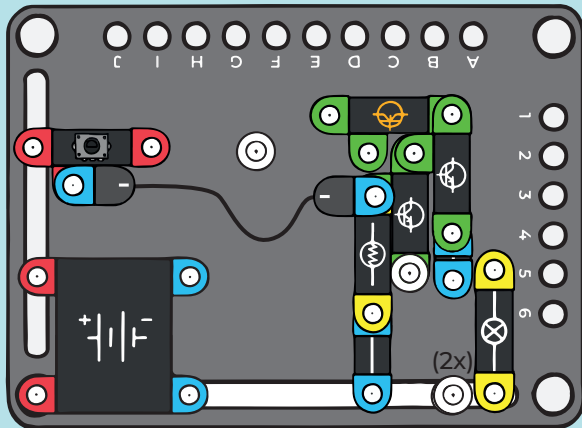

2.

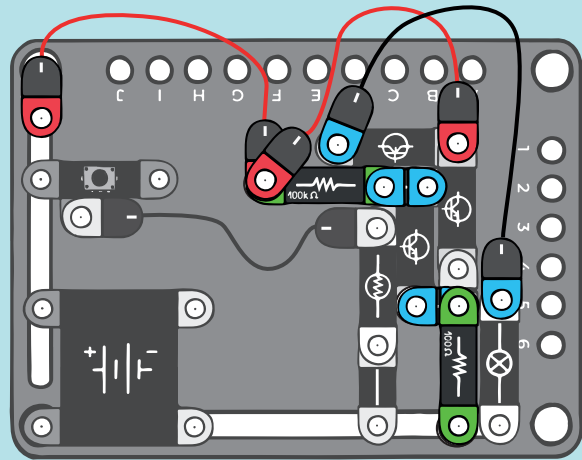



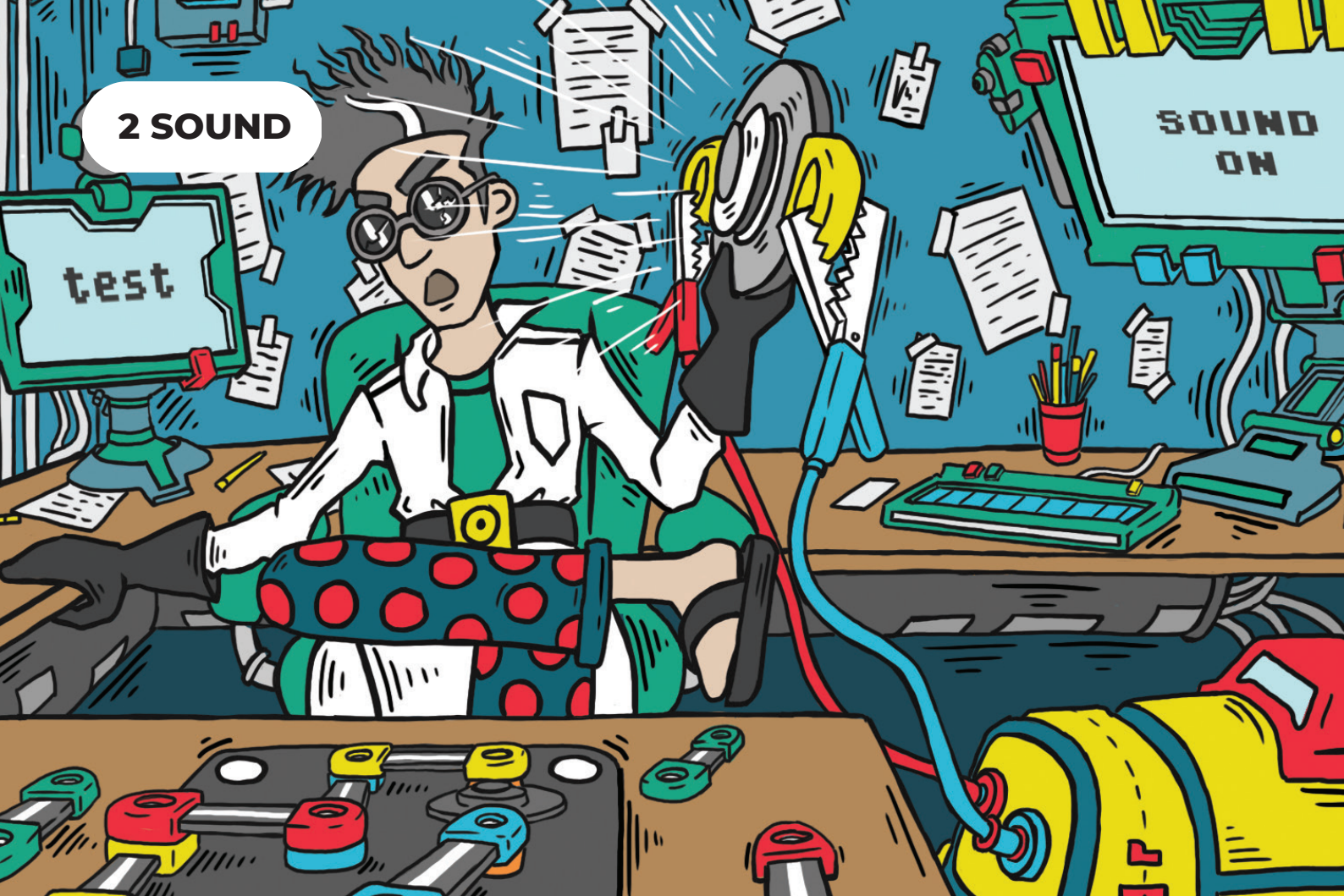

2 SOUND

test

SOUND
ON



S10 MULTIPLE-TONE GENERATOR I.

- 
 1x switch
- 
 1x transistor NPN
- 
 1x transistor PNP
- 
 1x speaker
- 
 1x battery
-  2x
  1x
- 
 1x LED
- 
 1x resistor 100kΩ
- 
 1x buzzer
-  3x
-  3x

This build demonstrates a change in tone of a simple buzzer depending on the capacitor. We will use a buzzer as the first place for the capacitor. Its membrane acts as a capacitor and has its own capacitance. The capacitance is relatively small and, therefore, the tone of the buzzer is high. The oscillation is so fast that we do not see the LED flashing and perceive it as constantly lit up.

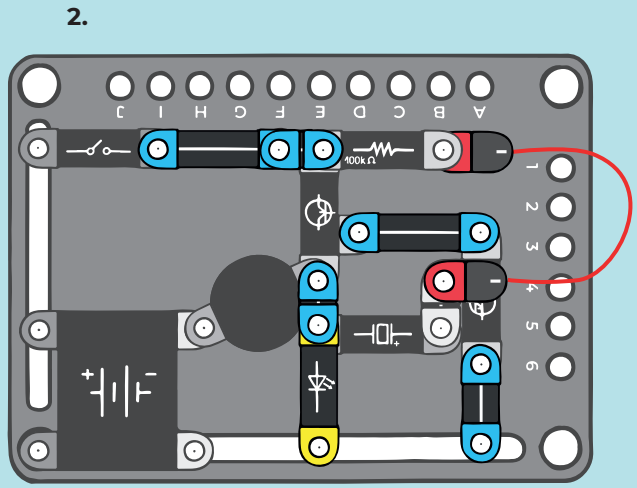
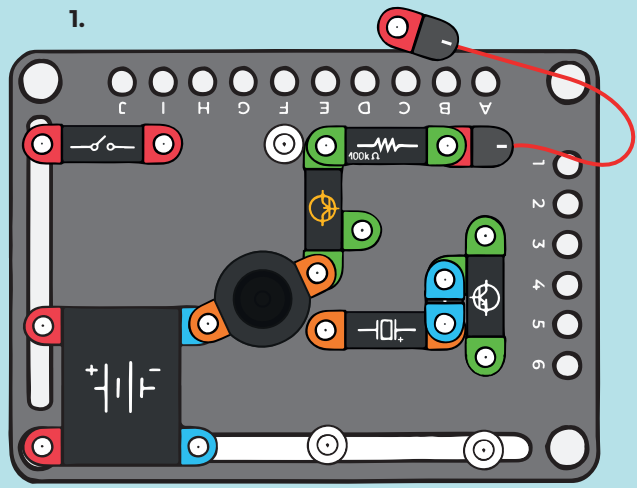







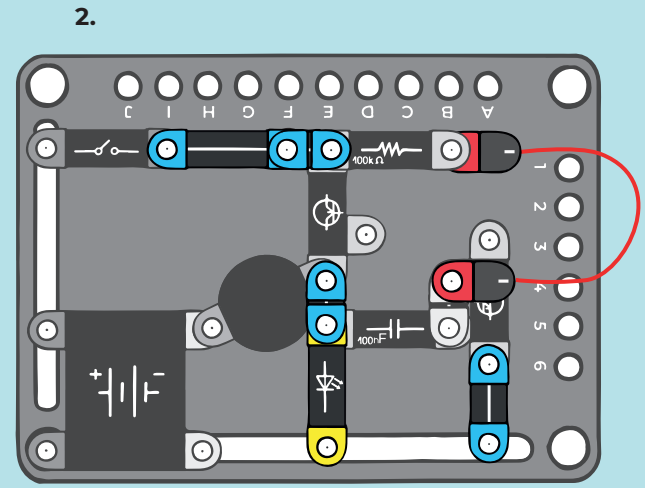
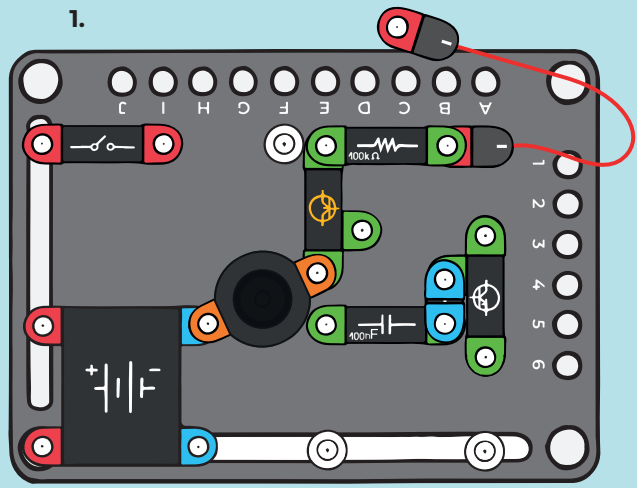

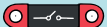

S20 MULTIPLE-TONE GENERATOR II.

- 
 1x switch
- 
 1x transistor NPN
- 
 1x transistor PNP
- 
 1x speaker
- 
 1x battery
-  2x
-  1x
-  1x
-  3x
- 
 1x LED
- 
 1x resistor 100kΩ
- 
 1x capacitor 100nF

We replace the buzzer with a capacitor with a capacitance of 100 nF. The capacitance is higher, and the tone pitch decreases. Again, the LED only appears to be constantly lit, but the brightness has changed. A good eye can already notice a hint of flicker – like rapid fluctuations in brightness.

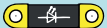

S30 MULTIPLE-TONE GENERATOR III.

- 
 1x switch
- 
 1x transistor NPN
- 
 1x transistor PNP
- 
 1x speaker
- 
 1x battery
-  2x
 1x
 3x
- 
 1x LED
- 
 1x resistor 100kΩ
- 
 1x capacitor 10µF
-  3X

Replace the capacitor with a capacitance of 100 nF with a capacitor with a capacitance of 10 µF. This capacitance is many times higher, and the continuous tone falls apart into mere clicking. The LED flashes. The generator frequency has dropped below the limit that a person can audibly perceive as a continuous tone.

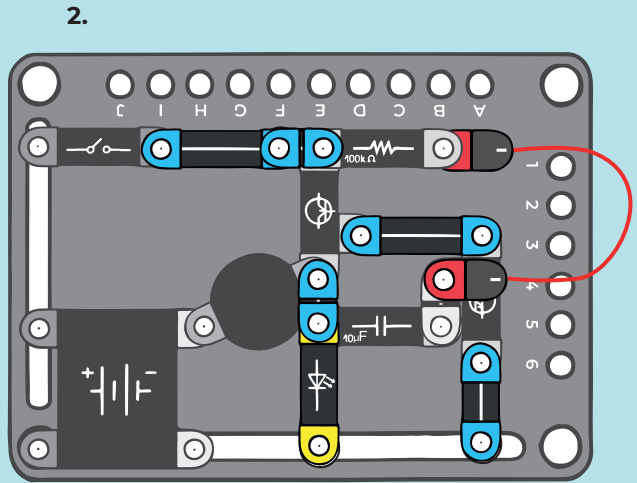
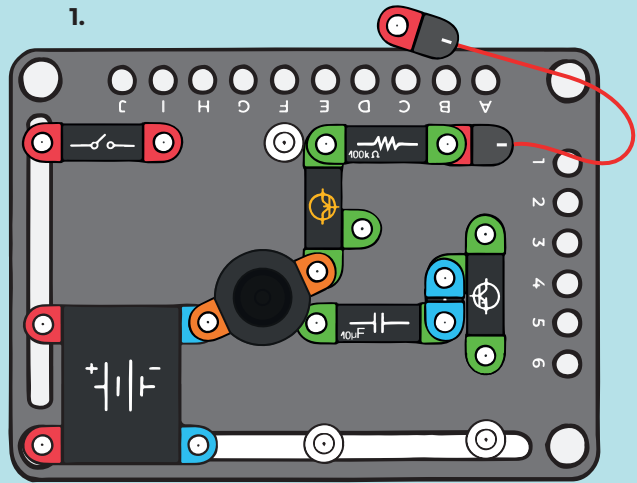

S40 ENGINE SOUND

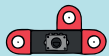

1x potentiometer



1x transistor NPN



1x transistor PNP



1x speaker



1x battery

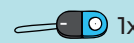

1x resistor 100Ω



1x resistor 1MΩ



1x capacitor 100nF

A sound generator can also be built using two amplifiers consisting of transistors of opposite conductivity. The circuit is simplified a bit, but the stability of the circuit is worse, which is reflected in a spontaneous change of tone. With its sound, this circuit resembles the operation of an internal combustion engine.

1.

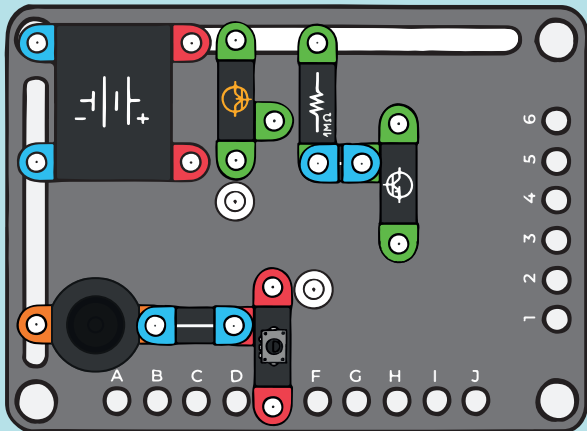

2.

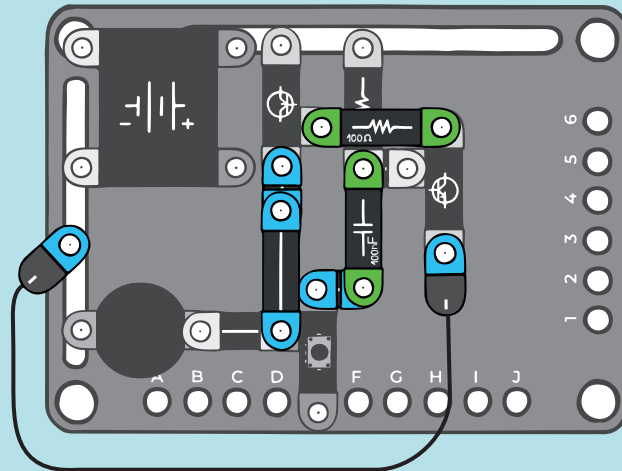

550 VOICE-CONTROLLED LIGHT

- 1x microphone
- 1x resistor 10kΩ
- 1x transistor NPN
- 1x battery
- 1x resistor 1MΩ
- 1x capacitor 10μF
- 1x LED
- 1x battery
- 1x push button
- 1x push button
- 2x push button
- 2x push button

By connecting a microphone and a transistor amplifier, you can control the LED brightness with sound. Unlike the L100 build, the microphone is connected in such a way that the supply current is separated from the current changes caused by the captured sound. The microphone is powered via a resistor. When sound is captured, this current changes, which causes a change in the loss of voltage at the resistor. The voltage change charges and discharges the capacitor, which generates a current, amplified by the transistor, that leads to a higher voltage for the LED as the transistor opens. The resistor supplying power to the microphone and the capacitor form a 'derivative circuit', which transmits only changes in the electric current, thus separating the change in electric current caused by sound and the current for supplying the microphone. The LED only lights up when the microphone registers sound.

1.

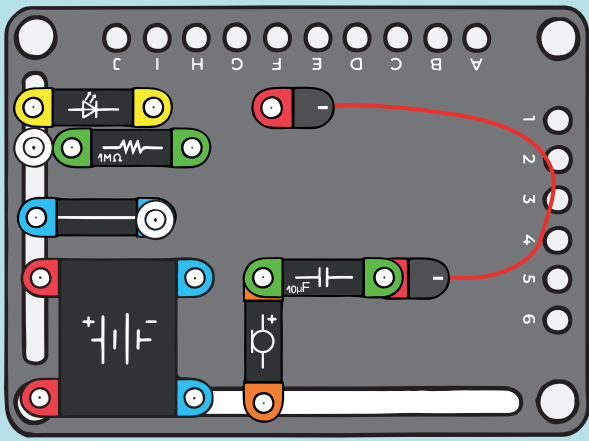

2.

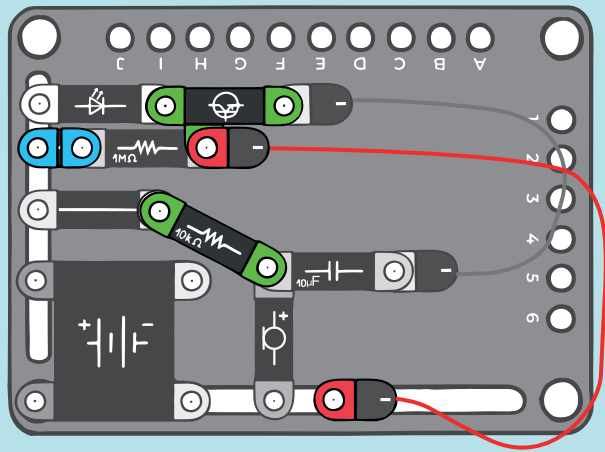

S60 MORSE CODE

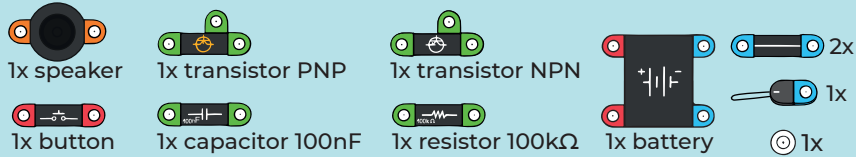

A simple buzzer with a button to practice the Morse code. This is a modified S40 circuit, where the selection of components achieves the characteristic tone used to receive Morse codes.

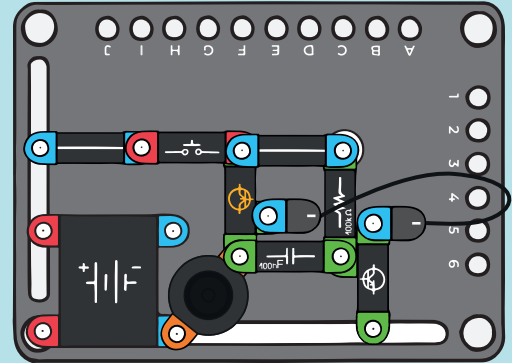

S70 APPLAUSE LED

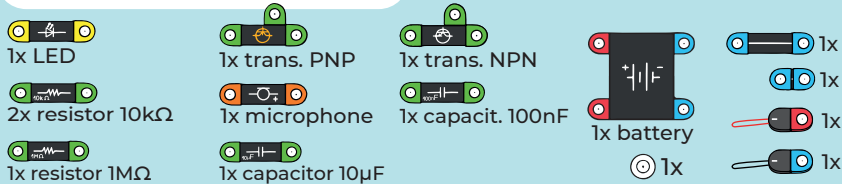

This is a modification of the S50 manual. We charge the capacitor with an amplified current from the microphone. The capacitor slowly discharges into the base of the second transistor. It is actually a similar circuit as L530, only differently connected. The LED lights up quickly with a sound and then slowly goes out.

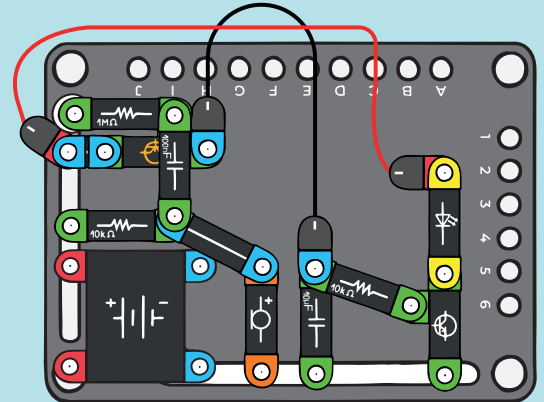

S80 BUZZING IN THE DARK

- 1x buzzer
- 2x transistor NPN
- 1x resistor 1kΩ
- 1x resistor 100Ω
- 1x fotoresistor
- 2x resistor 10kΩ
- 2x capacitor 100nF
- 1x battery
- 2x (red/blue) jumper
- 2x (blue/black) jumper
- 1x (blue/black) jumper

We can equip the astable flip-flop circuit not only with a photoresistor to change the pitch, as was the case in the L100 build, but with a suitable arrangement of components we can completely prevent the circuit from oscillating. If the photoresistor resistance falls below a certain limit due to illumination, the voltage at the transistor base will be so small that no current will flow to the transistor base. The transistor will be permanently closed, the circuit cannot oscillate further, and the tone will stop. In darkness, the resistance of the photoresistor increases, along with the voltage required for the current to flow to the base, and the circuit resumes the alternating opening of the transistors and thus oscillates. So the buzzer sounds again in the dark.

1.

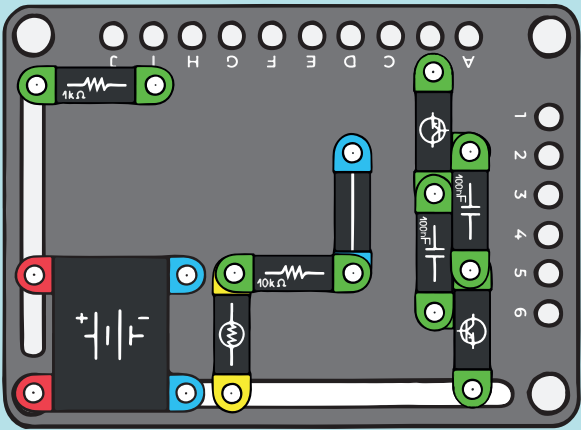

2.

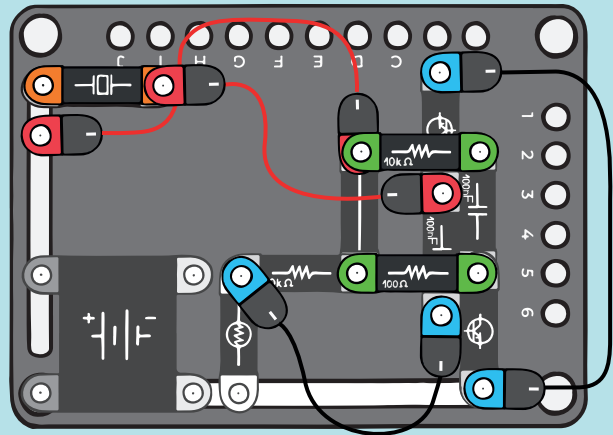

● S90 ADJUSTABLE TONE GENERATOR



1x potentiometer



2x transistor NPN

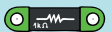

2x resistor 1kΩ



1x capacitor 100nF

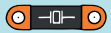

1x buzzer



2x resistor 10kΩ

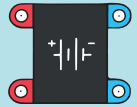

1x battery



1x



2x



2x

By suitably selecting components, we can force the L590 circuit to flip so rapidly that the change in electric current is able to cause the buzzer diaphragm to vibrate so fast that we hear a tone. In addition, we can use the potentiometer to influence the capacitor charging speed and thus change the pitch

1.

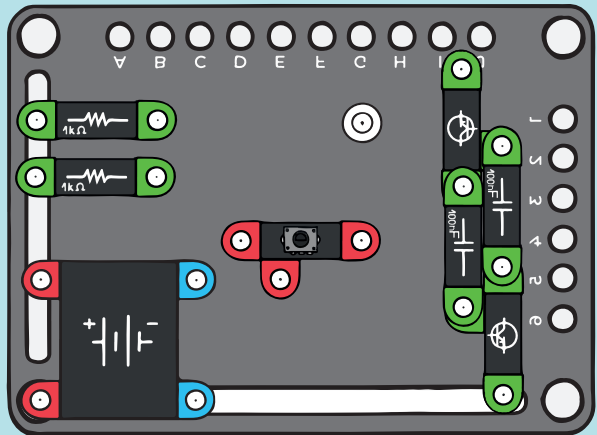

2.

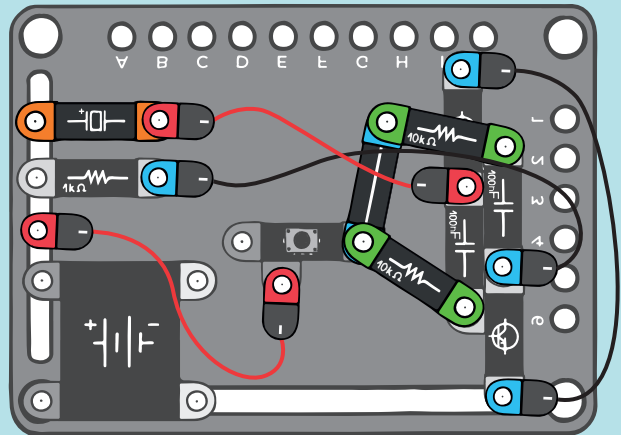

S100 PHOTSENSITIVE ELECTRONIC ORGAN

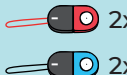
- 
 1x fotoresistor
- 
 2x transistor NPN
- 
 2x resistor 1kΩ
- 
 1x battery
- 
 2x capacitor 100nF
- 
 1x buzzer
- 
 2x resistor 10kΩ
- 
 1x
- 
 2x

You can connect a photoresistor instead of a potentiometer so the pitch will be directly proportional to the degree of illumination of the photoresistor.

1.

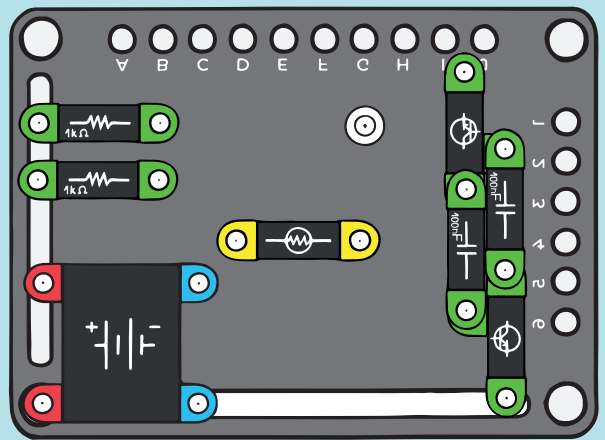



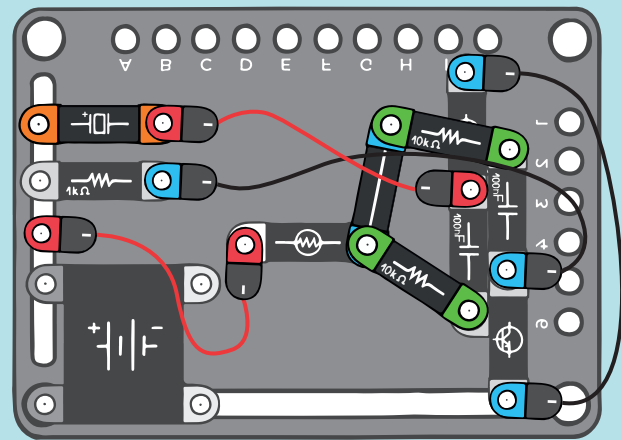



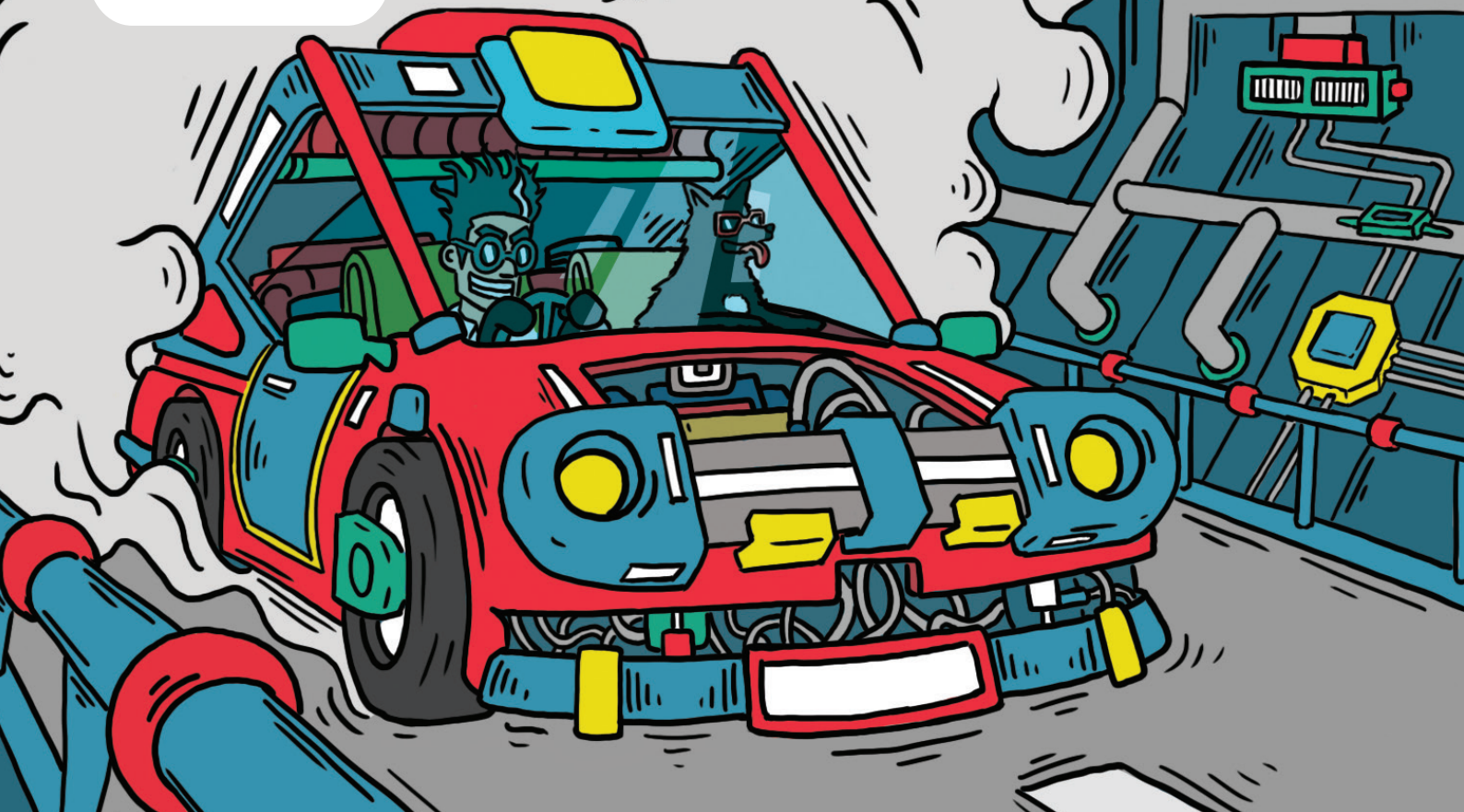

2.



3 ENERGY

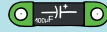

E10 CAPACITORS CONNECTED IN SERIES

- 
 1x switch
- 
 1x button
- 
 1x resistor 1kΩ
- 
 1x battery
- 
 2x
- 
 3x
- 
 1x LED
- 
 2x capacitor 100uF
- 
 1x

This build makes it possible to supply power to the LED diode from one capacitor (with the switch closed) or from two capacitors connected in series (with the switch open). Because the total capacitance of capacitors connected in series decreases, after charging the capacitor(s), the LED will light longer when the switch is closed. If the switch is open, the LED light duration will be about a half (two identical capacitors in series have a total capacitance of one half).

1.

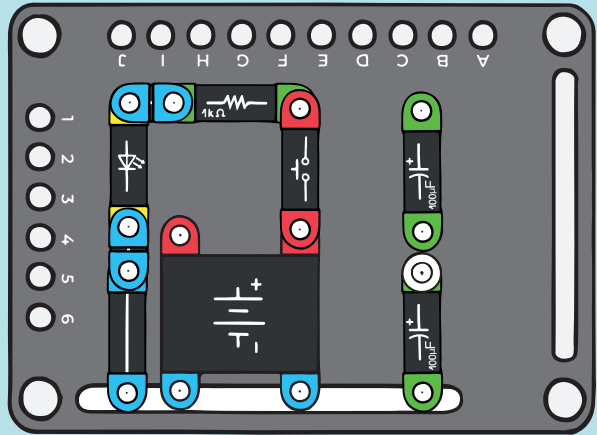

2.

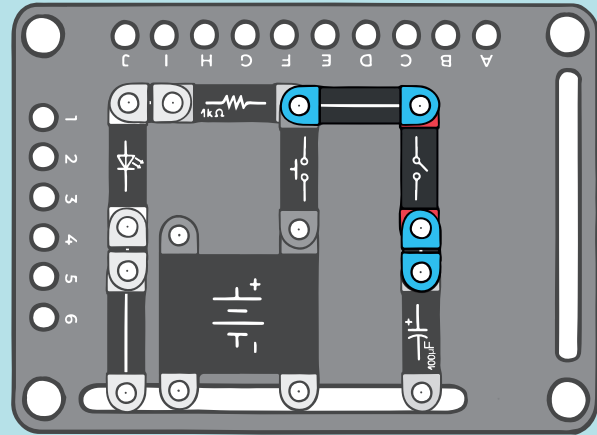

E20 CAPACITORS CONNECTED IN PARALLEL

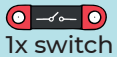

1x switch



1x button



1x resistor 1kΩ

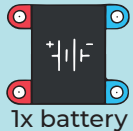

1x battery



3x



2x



1x LED



2x capacitor 100μF



1x



4x

The build allows to supply power to the LED diode from two parallel capacitors (with the switch closed) or from one capacitor (with the switch open). In the parallel arrangement of the capacitors, their total capacitance is added up; therefore, once the capacitor(s) have been fully charged, the LED will light longer when the switch is closed. When the switch is closed, the LED light duration will be roughly doubled (two identical capacitors in parallel have twice the resulting capacitance).

1.

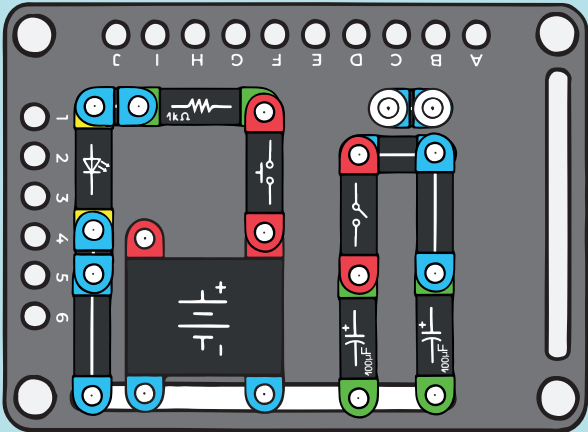

2.

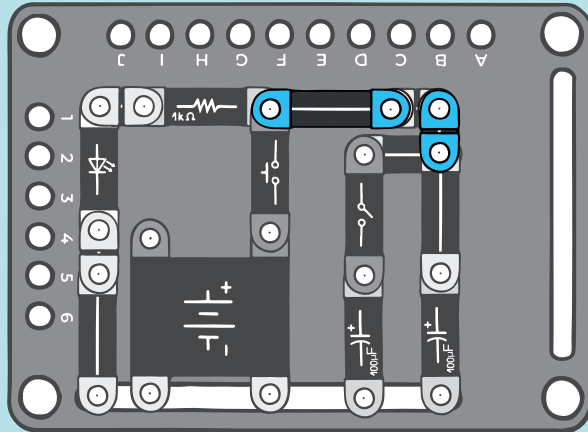

E30 YOUR OWN BATTERY I.

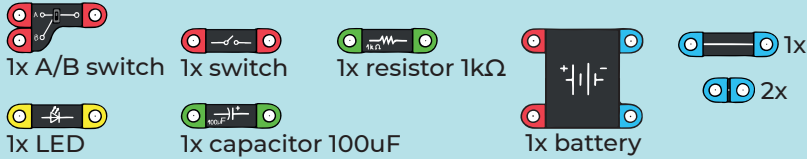

This circuit demonstrates the ability of the capacitor to accumulate an electric charge. By switching the capacitor to the battery, you will charge the capacitor and store electrical energy in it. When you switch it over to a LED, the energy in the capacitor is released in the form of an electric current that flows into the LED. The LED lights up. It is therefore powered from the capacitor. It is only possible to store and release energy when the switch is closed and, thus, the capacitor and LED circuit is closed.

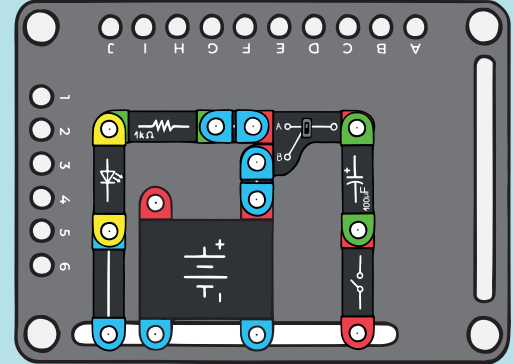

E40 YOUR OWN BATTERY II.

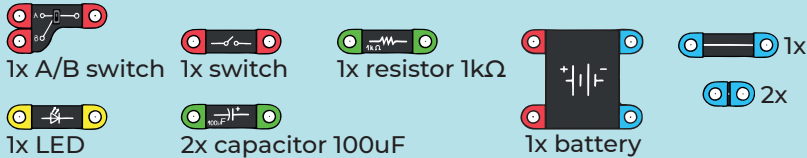

This build is identical to the previous version but contains two capacitors connected in parallel. The capacitor bank thus has a double capacitance. The LED will light up for a longer time.

Add a capacitor to the previous build

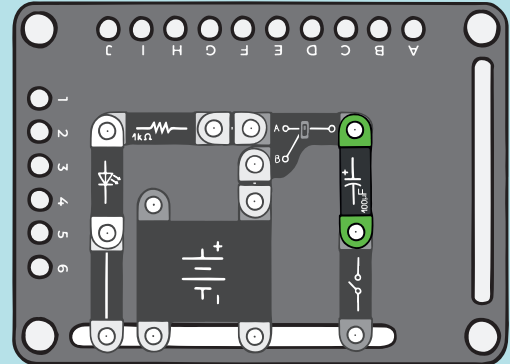

E50 YOUR OWN BATTERY III.



1x A/B switch



1x switch



1x resistor 100Ω



1x battery



1x



1x LED



2x capacitor 100μF



2x

If you increase the current passing through the LED by reducing the value of the ballast resistor from 1 kΩ to 100 Ω, the current flowing through the LED diode will increase 10 times. The brightness will increase and the capacitor bank will be discharged earlier, so the LED will be on for a shorter time.

Adjust the previous build

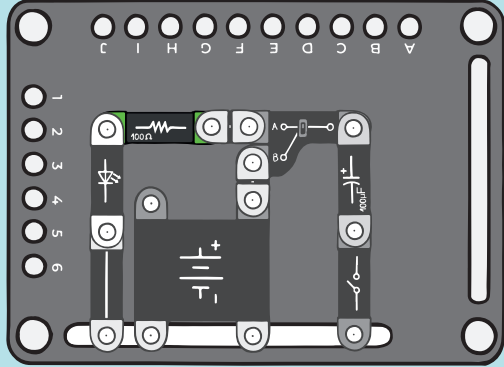

E60 YOUR OWN BATTERY IV.

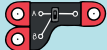

1x A/B switch

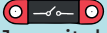

1x switch



1x resistor 10kΩ



1x battery



1x

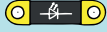

1x LED

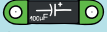

2x capacitor 100μF







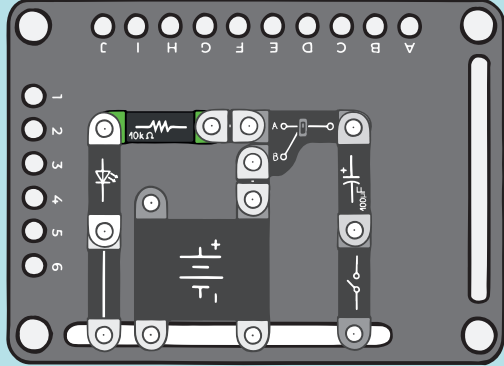

2x

Increasing the value of the ballast resistor to the LED will decrease the brightness and reduce the discharge current. The LED will last longer. As a result, you do not need to add more energy storage to extend the time provided by the capacitor, but you can start by reducing consumption.

Adjust the previous build



E70 CHARGING AND DISCHARGING THE CAPACITOR I.

- 
 1x button
- 
 1x resistor 100Ω
- 
 1x switch
- 
 1x battery
- 
 2x LED
- 
 1x capacitor 100uF
- 
 1x resistor 1kΩ
- 
 2x LED

Charging and discharging the capacitor is controlled by two buttons and indicated by two LEDs. A fully charged capacitor is indicated after pressing the button with the green LED flashing. Once the capacitor has fully been charged, no current flows into the capacitor (the green LED is off) because the voltage on the capacitor is the same as on the battery. The capacitor can be discharged by pressing the second button, which is indicated by the red LED. After the stored charge is depleted, no current flows through the discharge circuit with the red LED and the LED can no longer light up.



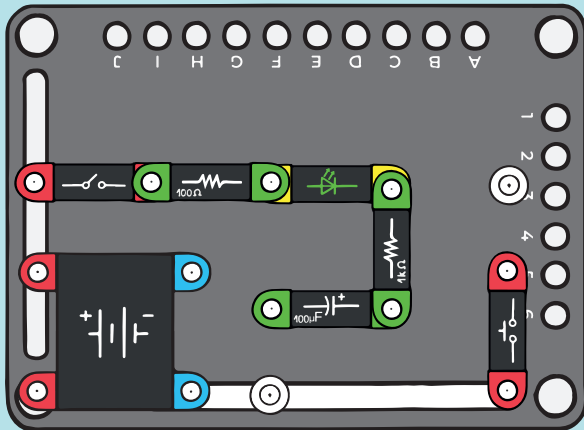



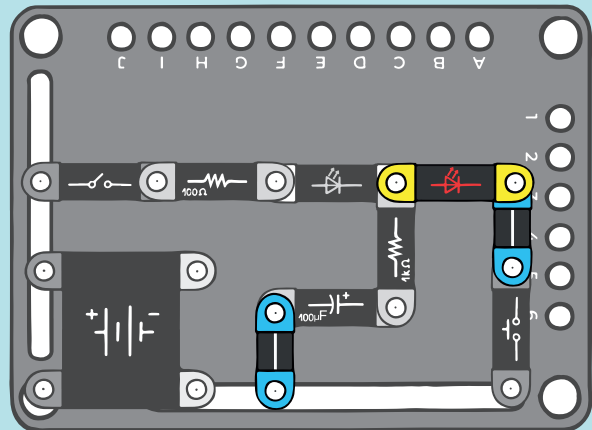

1.

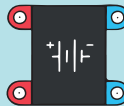

2.



E80 CHARGING AND DISCHARGING THE CAPACITOR II.

- 
 1x button
- 
 1x resistor 100Ω
- 
 1x switch
- 
 1x battery
- 
 2x
- 
 2x capacitor 100μF
- 
 1x resistor 1kΩ
- 
 2x LED
- 
 2x

By connecting the second capacitor in parallel, you will double the capacitance of the capacitor bank. Both LEDs will light up for about twice as long during charging and discharging. The function of the circuit is the same as for E80.

1.

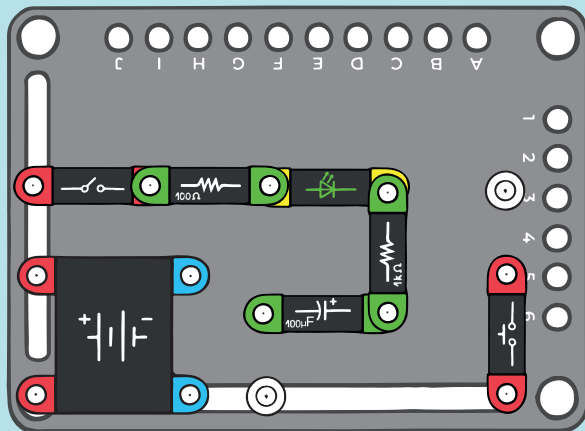

2.

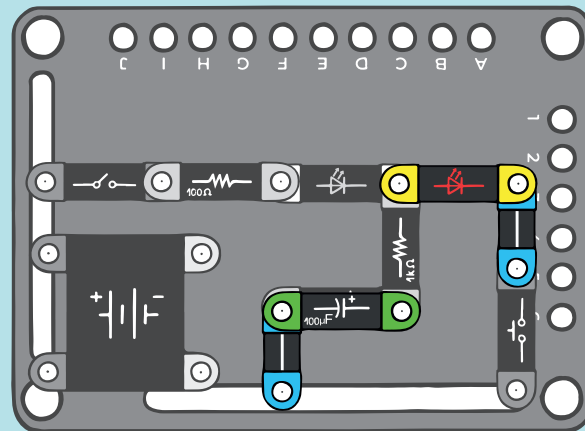

4 MEASUREMENT

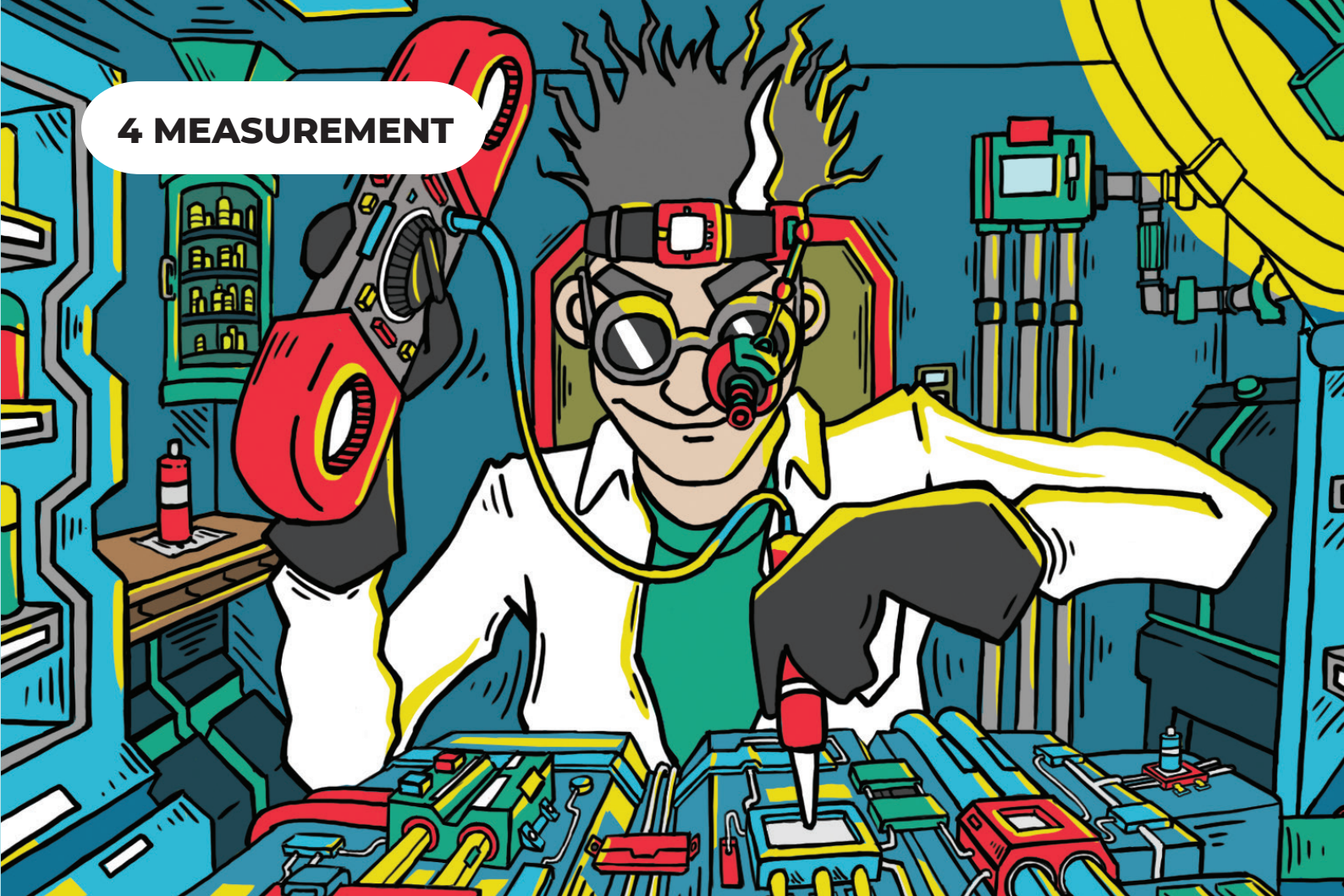

M10 COMPRESSION METER



1x speaker



1x transistor NPN



1x transistor PNP

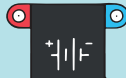

1x battery



1x



2x



2x



1x



1x



1x resistor 10kΩ



1x capacitor 100nF

As we know from the L240 build, our skin is conductive, especially when wet. If you replace the resistor in the simple buzzer described under S20 with conductors, then the resistance between the conductors will depend on the degree of compression between them. A fixed resistor is included in the circuit as a safety element so that, in the event of a short circuit of both conductors, the NPN transistor is not destroyed by too much current flowing to the base.

Warning: Never connect the red conductor directly to the positive terminal of the battery. There is a risk of the NPN transistor getting damaged!



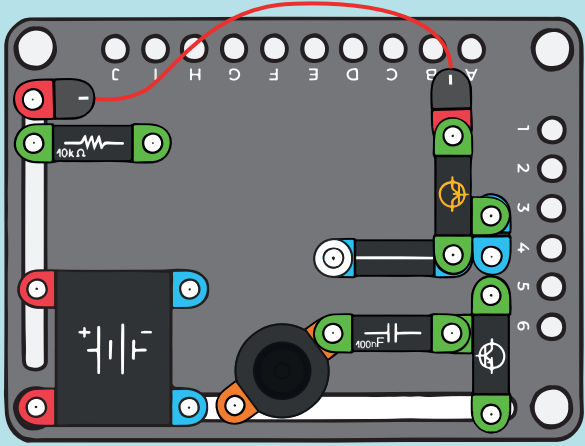



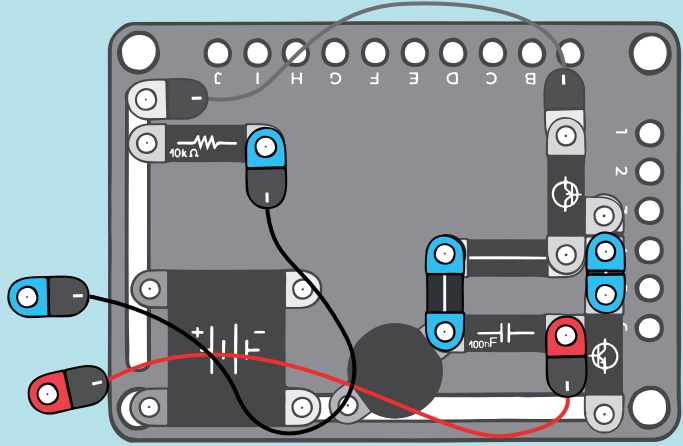

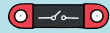
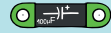

1.

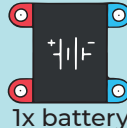

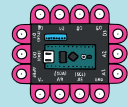
2.

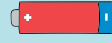

M20 VOLTAGE METER







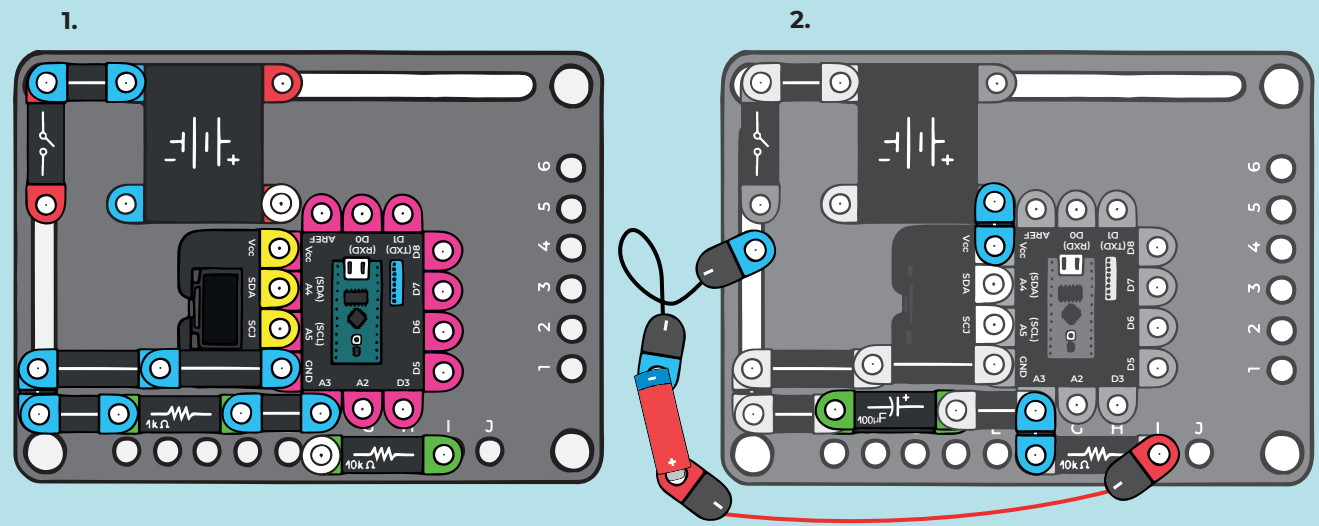



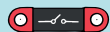

- 
 1x switch
- 
 1x capacitor 100µF
- 
 1x display
- 
 1x battery
-  2x
-  1x
- 
 1x micro computer
- 
 1x resistor 10kΩ
- 
 1x resistor 1kΩ
- 
 1x battery
-  3x
-  1x
-  3x
-  2x

Each electrical device is powered by electrical energy, which can come from a battery or a power generator. In both cases, the source supplies an electric current of a certain voltage to the circuit. For batteries it is 1.5V, 9V or other voltage. As the battery discharges over time, its voltage also decreases. With this circuit, you can measure whether you can still use the battery or not. Attach the free terminals to the battery, with the red conductor placed on the positive contact and the black one on the negative contact.

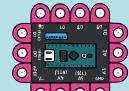
Set the switches on the microcomputer to the ON position. In this build, it will only be Changeover Switch 6. *Tip: if you do not know where to set the changeover switches, see the Games section on Page 91 for more detailed pictures.*



M40 DIODE FORWARD DIRECTION MEASUREMENT

- 
 1x switch
- 
 1x potentiometer
- 
 1x display
- 
 1x battery
- 
 1x
- 
 1x
- 
 1x
- 
 1x micro computer
- 
 1x resistor 100Ω
- 
 1x capacitor 100nF
- 
 1x diode
- 
 1x
- 
 1x
- 
 3x

By connecting a diode to the circuit in the forward direction, you can determine its voltage drop and then also the output power loss during the passage of current. Conventional diodes tend to have a voltage drop between 0.2 and 1.5V. It depends on the production technology and also the purpose of use. The power diodes that you can find in electric locomotives can reach a pass voltage of just about 1.5V. On the contrary, common silicon or special diodes have a voltage mostly around 0.7V. Furthermore, the pass voltage depends on the magnitude of the current flowing through the diode. The higher the current, the higher the voltage drop across the diode. Test what voltage you can measure.

Set the changeover switches on the microcomputer to the ON position. For this circuit, set Changeover Switches 2 and 6.

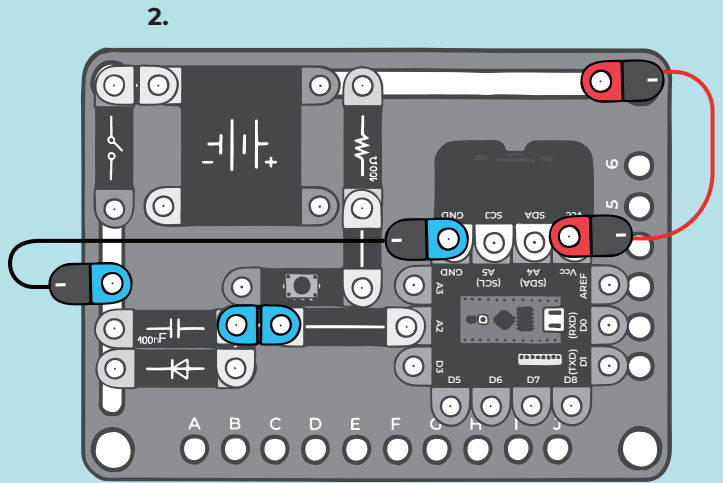
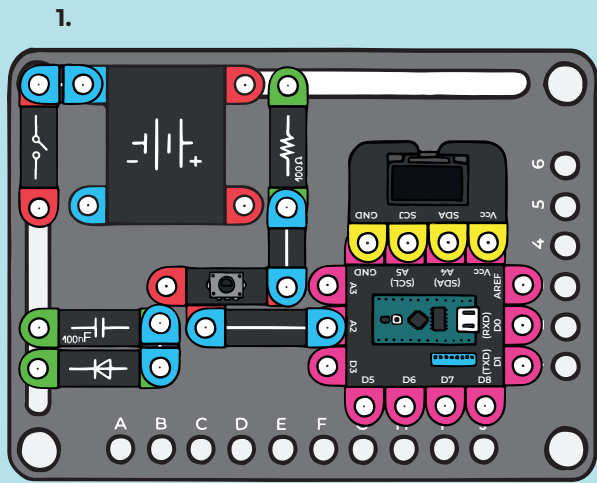

M50 LED FORWARD DIRECTION MEASUREMENT

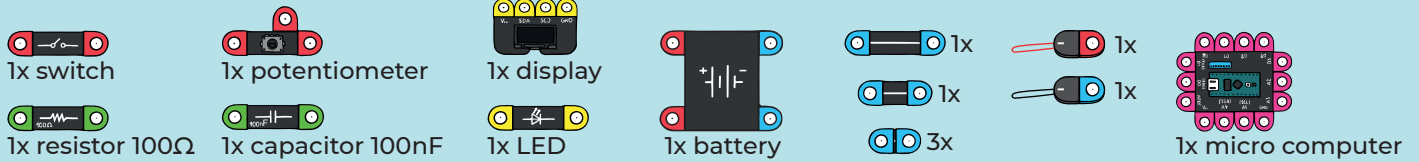

You can use the same circuit as in the previous build, just connect a light-emitting diode instead of a diode. Verify that different colors may have different voltages in the forward direction, depending on the technology that is used to manufacture them.

Set the changeover switches on the microcomputer to the ON position. In this build, set Changeover Switches 1, 2 and 6.

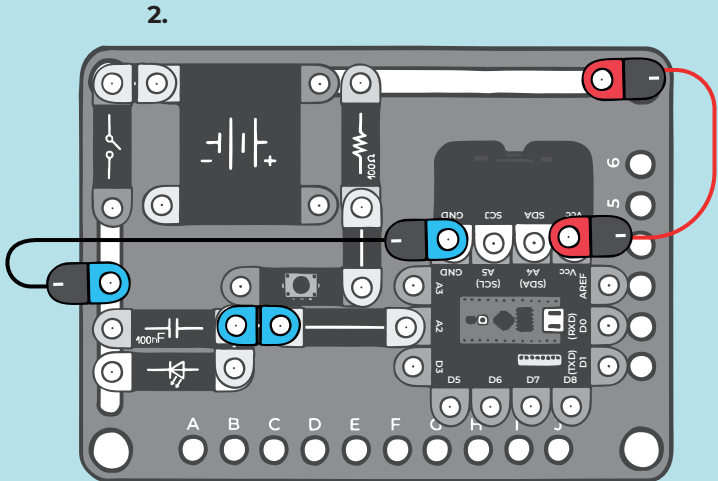
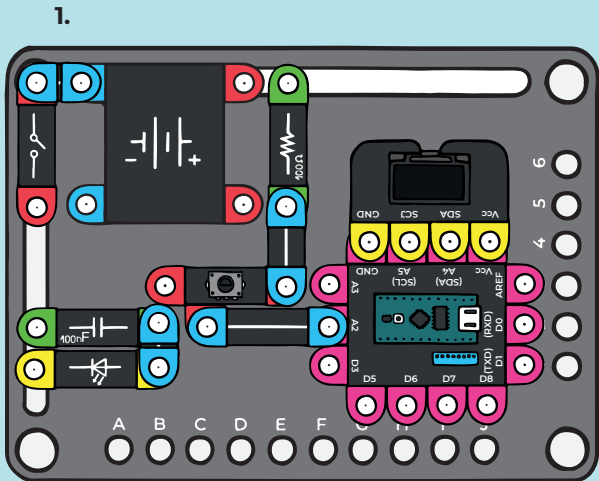

M60 LUMINANCE LEVEL MEASUREMENT



1x fotoresistor



1x capacitor 100nF



1x display

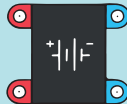

1x battery

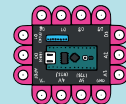

1x micro computer



2x



1x

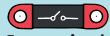

1x switch



1x resistor 10kΩ



3x



1x



1x

You can test the conversion of a non-electric quantity into its digital representation in this task, where you create a resistive voltage divider and connect a ballast resistor in one part and a photoresistor in the other as an element responding to the intensity of illumination. The higher the luminance intensity, the lower the resistance the resistor will have. See how the voltage on the resistive voltage divider will change when you cover the photoresistor with your finger or expose it to sunlight.

Set the changeover switches on the microcomputer to the ON position. In this circuit, set Changeover Switches 3 and 6.

1.

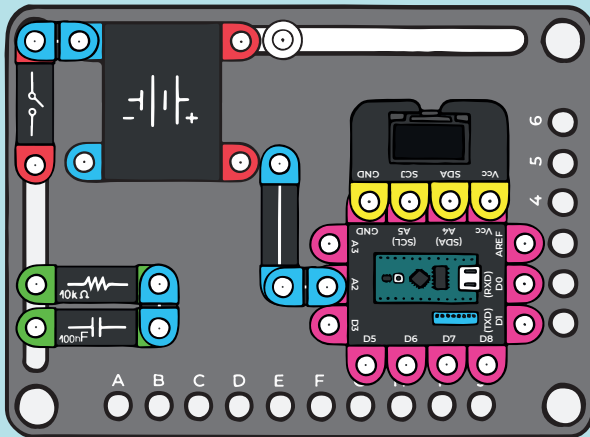

2.

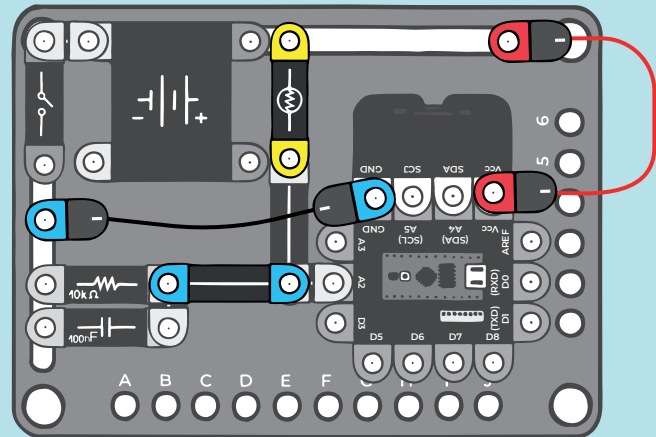

5 GAMES

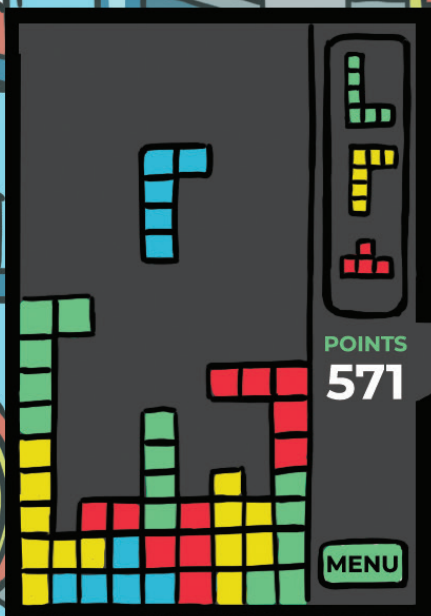

G10 FAST REFLEXES

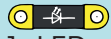

1x LED



1x resistor 1kΩ



1x display

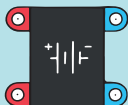

1x battery



2x



2x



1x



1x

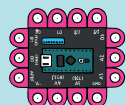

1x micro computer

A circuit for measuring how fast your reflexes are (reaction times to an optical stimulus). It is a fun and yet a practical build. Before assembling the circuit as shown in Figure 1, first adjust the position of the changeover switches as shown in Figure 2. Press the lower button to start the measurement. Then wait for the LED to light up and as soon as it happens, press the button under the LED as quickly as possible. Your reaction time will appear on the display. This way you can compete with friends or test your own reaction time according to the time of day.

1.

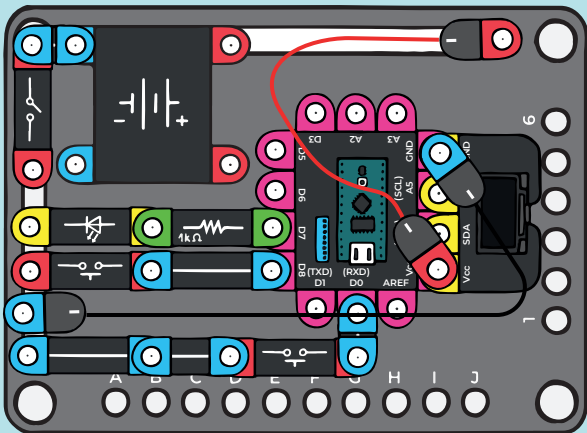

2.

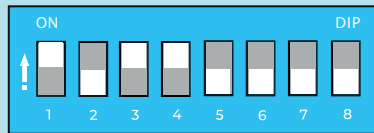

G20 PLATFORM GAME WITH BOFFIN

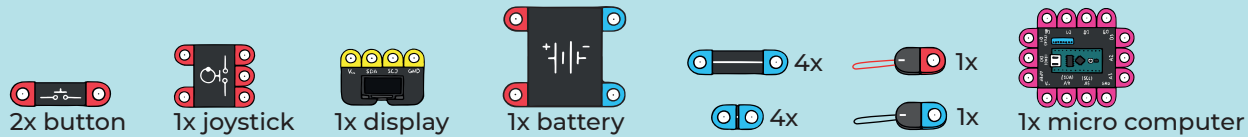

Make your own game console with a microcomputer, buttons and joystick. Before assembling the circuit as shown in Figure 1, first adjust the position of the changeover switches as shown in Figure 2. Then you can start playing and help the Boffin figure complete the mission. Do not disassemble the connected project as you will use it in other projects.

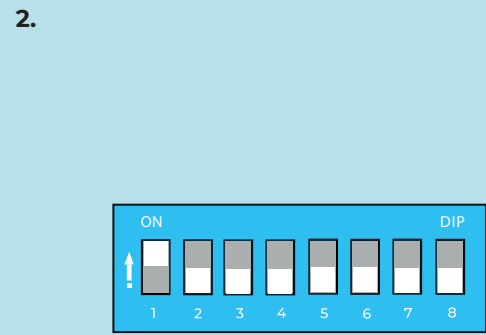
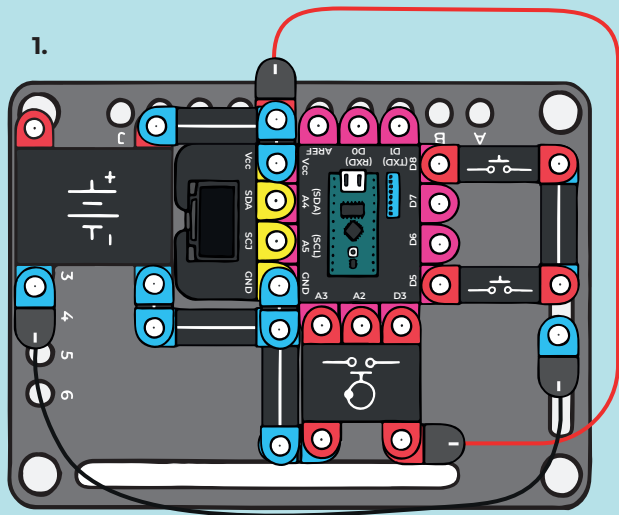

G30 PING PONG MULTIPLAYER

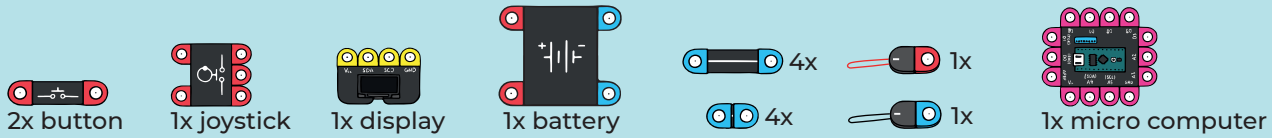

In the previous project, you learned how to build a game console using Boffin Magnetic. Now it is time to play a game against a friend. First, adjust the position of the changeover switches as shown in Figure 2. This will take you to a game called Ping Pong. This game is meant for two players. One of the players uses two buttons and the other one a joystick. To keep the game fair, we recommend swapping the controls after each game.

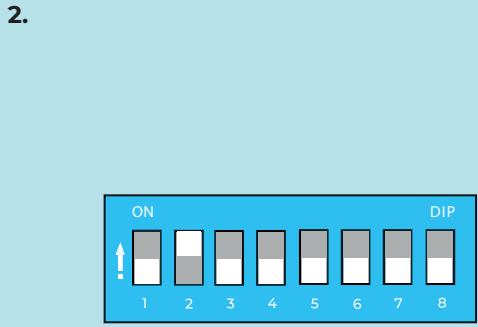
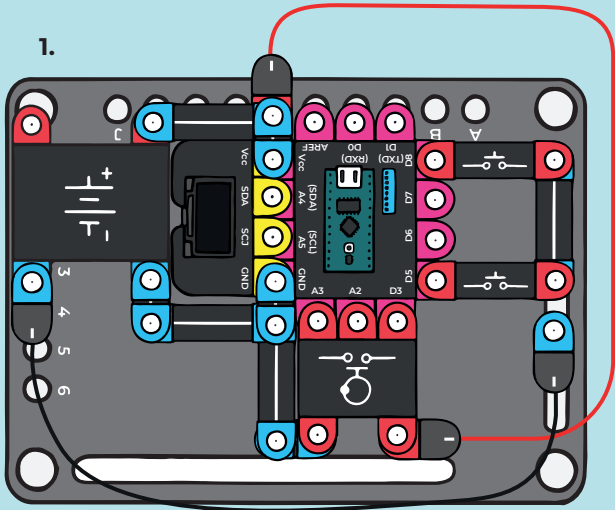

G40 TETRIS

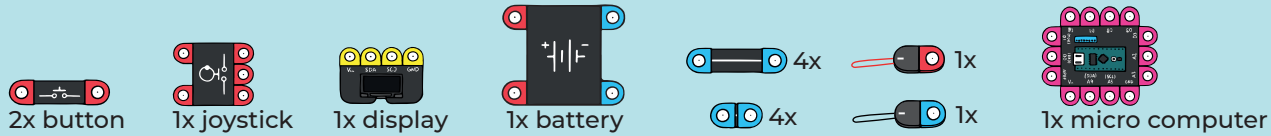

In previous projects, you learned how to assemble a game console using Boffin Magnetic. The connected circuit is the same as in the previous builds. Just change the position of the changeover switches as shown in Figure 2. At this point, you have entered the game of Tetris and your task is to reach the highest score. Can you beat Boffin himself?

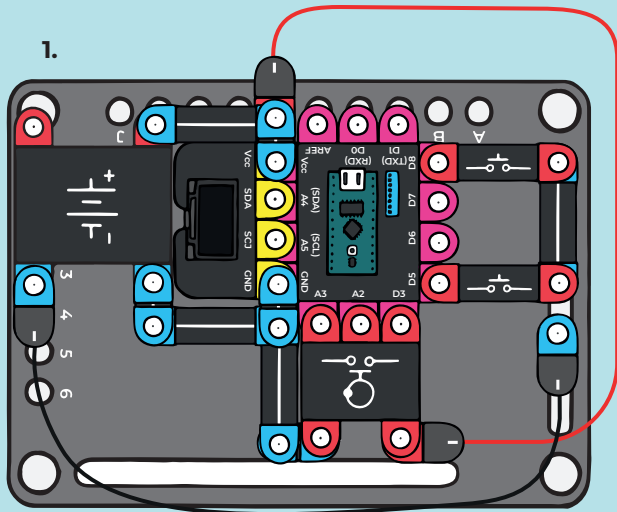

2.

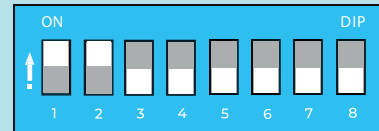

G50 ROXY CATCHES DICE



1x joystick



1x display

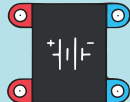

1x battery



3x



4x



1x

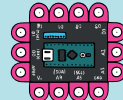

1x micro computer

In previous projects, you learned how to build a game console using Boffin Magnetic. This build remains almost the same as in the previous projects, just remove the two buttons and leave the joystick. Then change the position of the changeover switches as shown in Figure 2. At this point, you get into a game where a dog named Roxy catches dice or hearts, but watch out for bombs that take your lives.

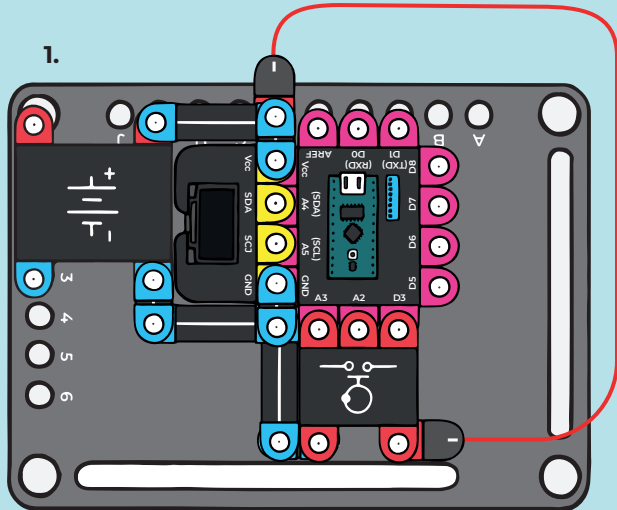

1.

2.

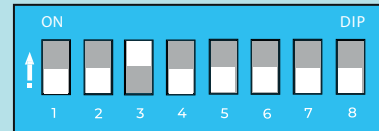

G70 SHOOTING DOWN THE DICE

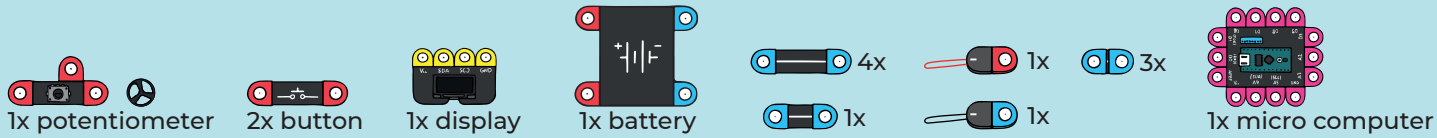

In this project you will be able to build a console that you will use for racing games and shooters. We replaced the joystick with a potentiometer, which changes its internal resistance by turning and can thus be used for direct control. You can attach a steering wheel to the potentiometer which will give you a more realistic experience. Before assembling the circuit according to Figure 1, set the positions of the changeover switches according to Figure 2.

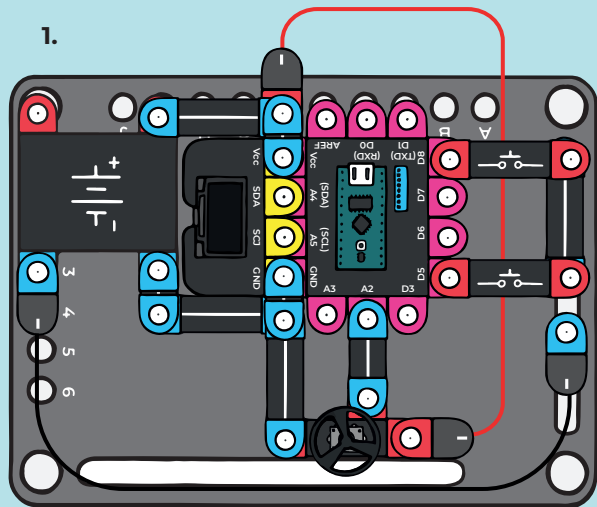

2.

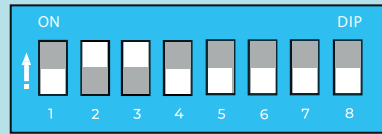

G80 SPACE SHOOTER

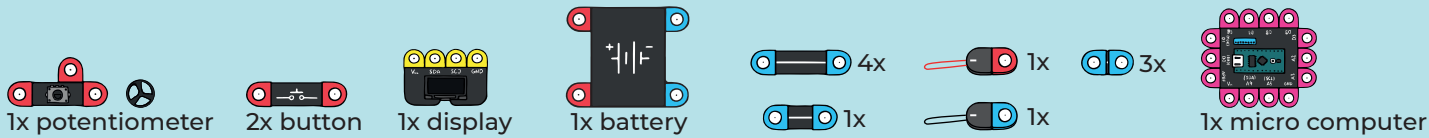

In this project you will be able to build a console that you will use for racing games and shooters. The circuit remains the same as in the previous project. Just adjust the position of the changeover switches as shown in Figure 2. Now you can go on a space mission and save the whole world.

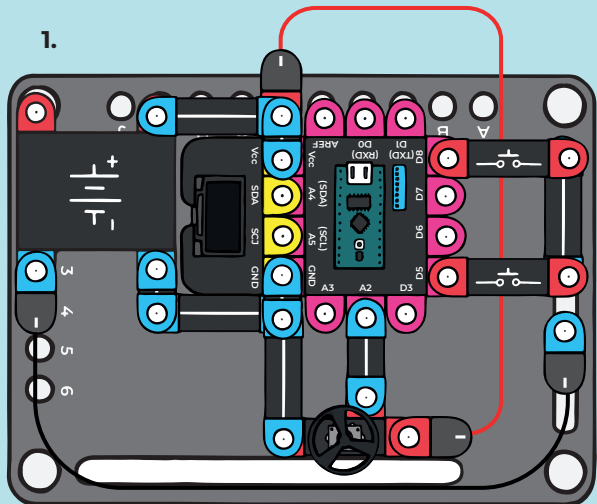

2.

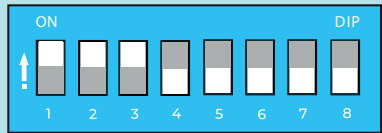

G90 RACING GAME I.

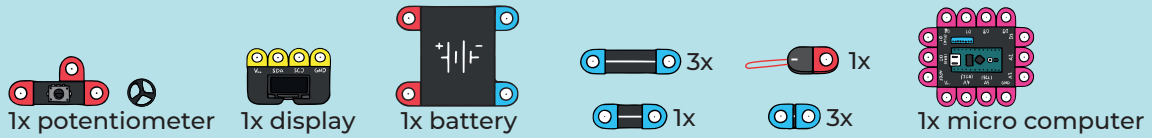

Build a racing simulator. You can steer using a potentiometer (it changes its internal resistance by turning and can thus be used for direct control) on which you place a plastic steering wheel. Before assembling the circuit according to Figure 1, set the position of the changeover switches according to Figure 2. Now there is nothing stopping you from taking up on the role of a Formula 1 pilot.

1.

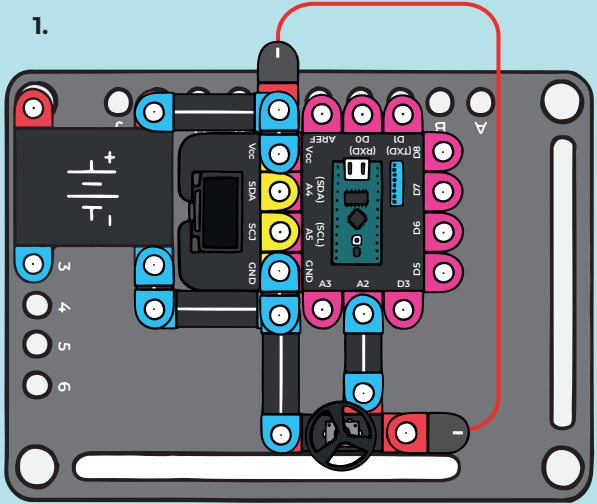

2.

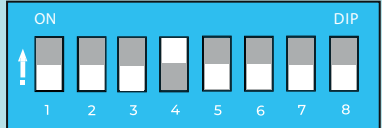

G100 RACING GAME II.



1x potentiometer



1x display



1x battery



3x



1x



1x



3x

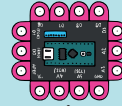

1x micro computer

Build a racing simulator. You can steer using a potentiometer (it changes its internal resistance by turning and can thus be used for direct control) on which you place a plastic steering wheel. Before assembling the circuit according to Figure 1, set the position of the changeover switches according to Figure 2. This is an advanced level of the previous game.

1.

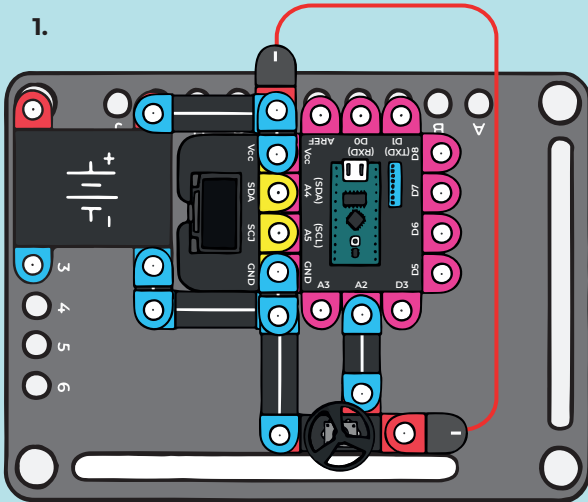

2.

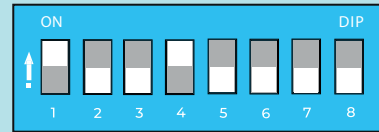

G110 SNAKE

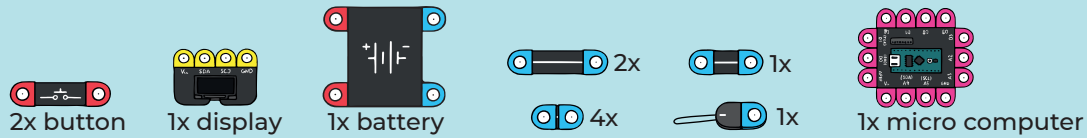

Build a simple game console. You only have two buttons, but as usual, that is enough to control most funny games, such as the classic snake. Before assembling the circuit according to Figure 1, set the position of the changeover switches according to Figure 2. In this game you have only one task, and that is to achieve the highest possible score.

1.

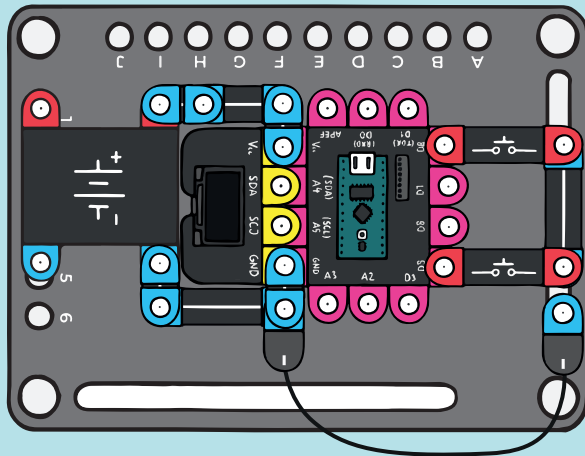

2.

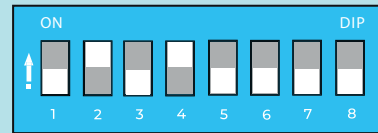

G120 JUMPING WITH BOFFIN

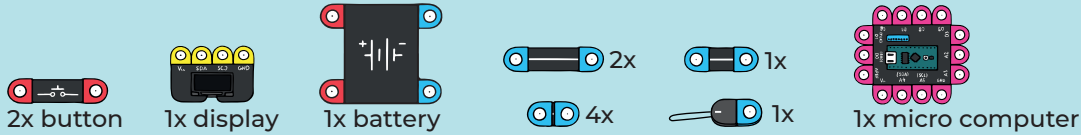

Build a simple game console. You only have two buttons, but as usual, that is enough to control most funny games. Before assembling the circuit according to Figure 1, set the position of the changeover switches according to Figure 2. This game has been personally prepared for you by the Boffin figure, and your task is to bring the figure to the end of a thorny path along which you will run, having to jump over specific obstacles. I wish you good luck.

1.

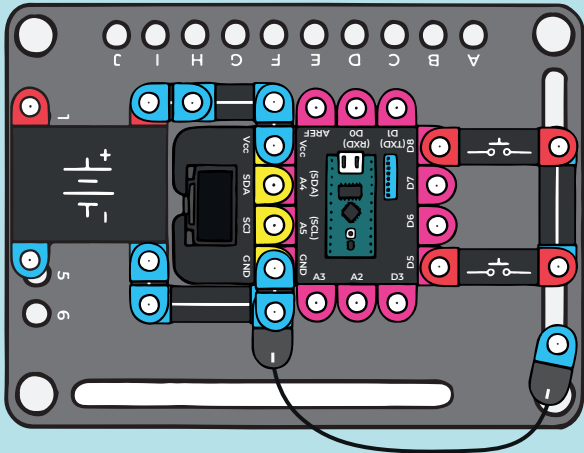

2.

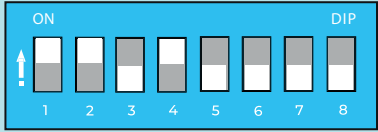

G130 LOGIC GAME WITH BOFFIN

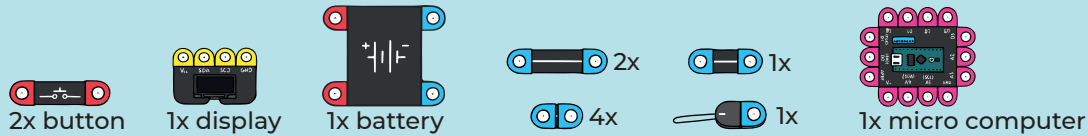

Build a simple game console. You only have two buttons, but as usual, that is enough to control most funny games. Before assembling the circuit according to Figure 1, set the position of the changeover switches according to Figure 2. This game is mainly about your knowledge. Boffin will ask you tricky questions and it is up to you how fast you answer them and how far you progress in this game.

1.

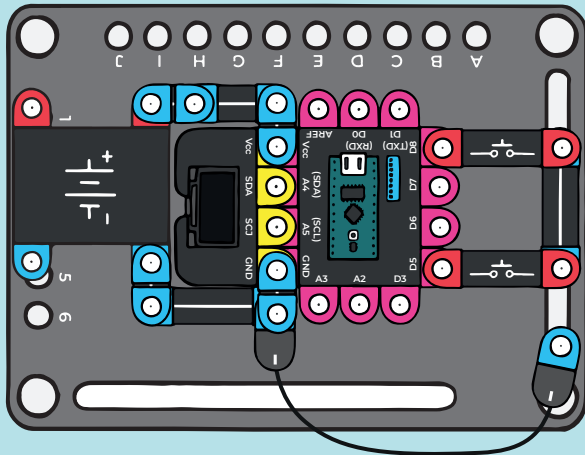



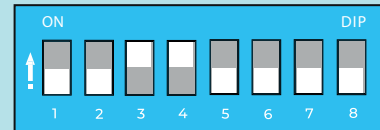



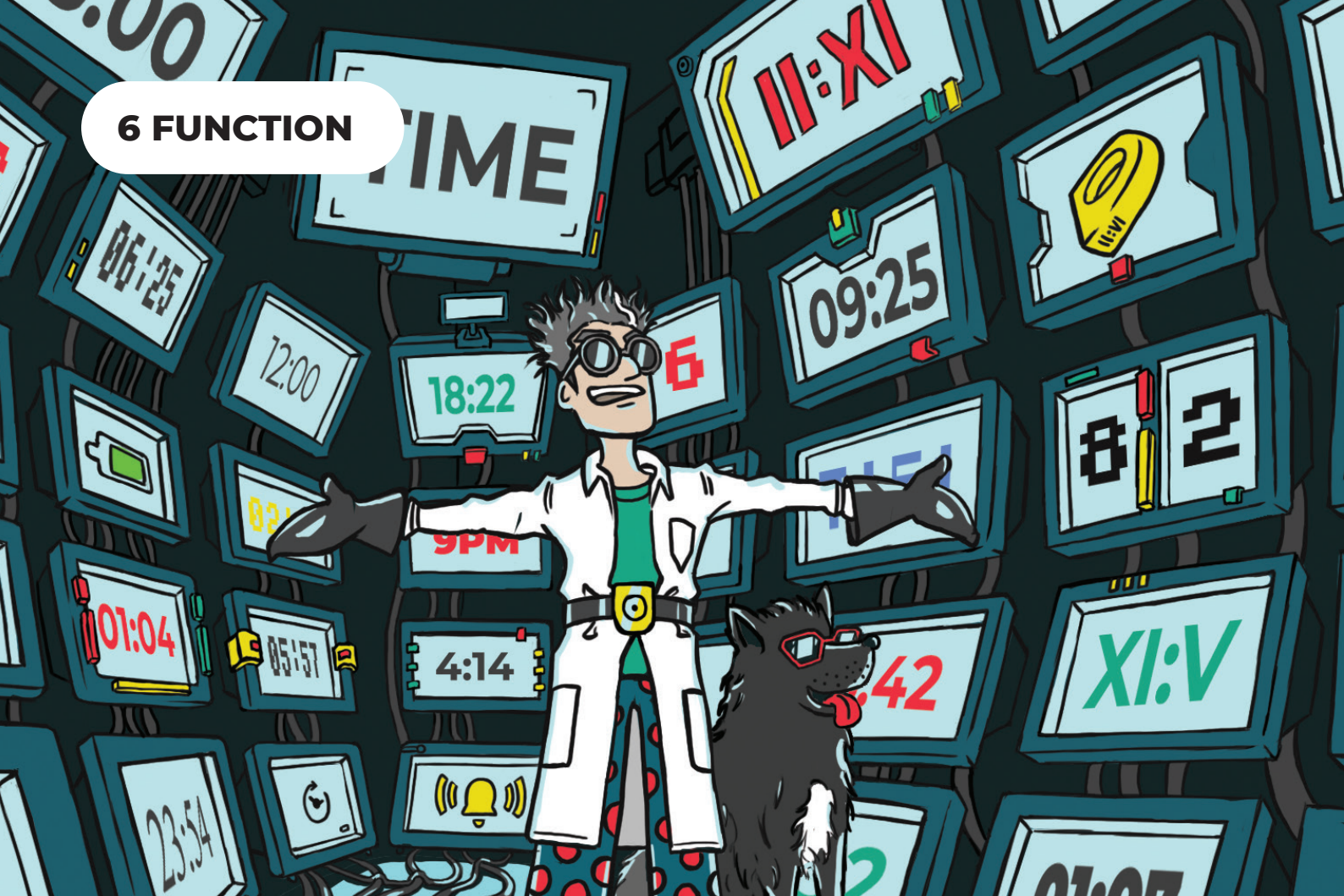

2.

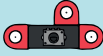

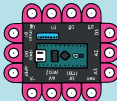
6 FUNCTION

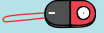
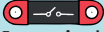
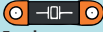

F20 CLOCK

- 
 2x button
- 
 1x potentiometer
- 
 1x display
- 
 1x battery
- 
 1x micro computer
- 
 1x
- 
 1x
- 
 1x switch
- 
 1x buzzer
- 
 3x
- 
 2x
- 
 1x

There are many things you can do with a microcomputer, but how about doing something to help you get up for school or work? Build a simple clock with an alarm function. As soon as you set the alarm, put it as far away from your bed as possible so that you can be sure that you will not destroy the connection in the morning and that you will get up. Set the changeover switches to the correct position, as you learned in the previous chapter. In this case, set Changeover Switches 1, 6 and 7 to the ON position.

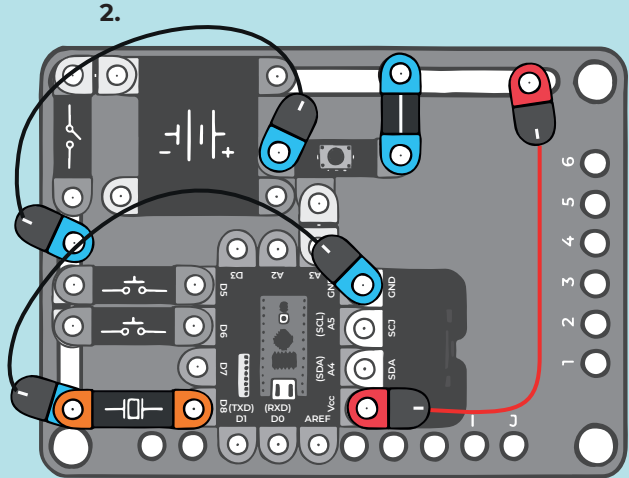
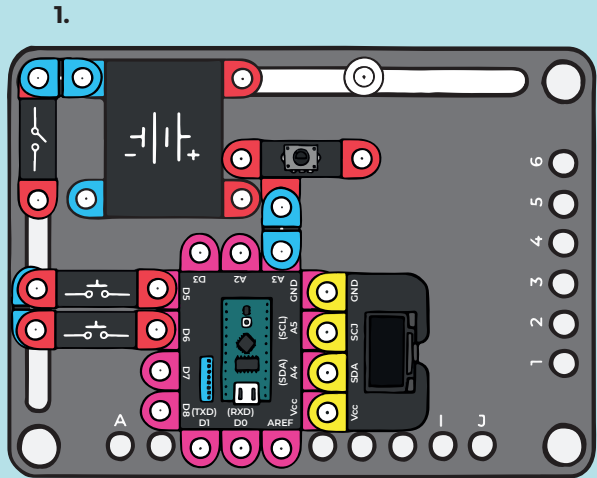

You have made it!!

I hope you have had a great time. If you do not have enough yet (and I hope you don't), do not forget that you can find more projects on our website!

www.boffinmagnetic.com/community/projects

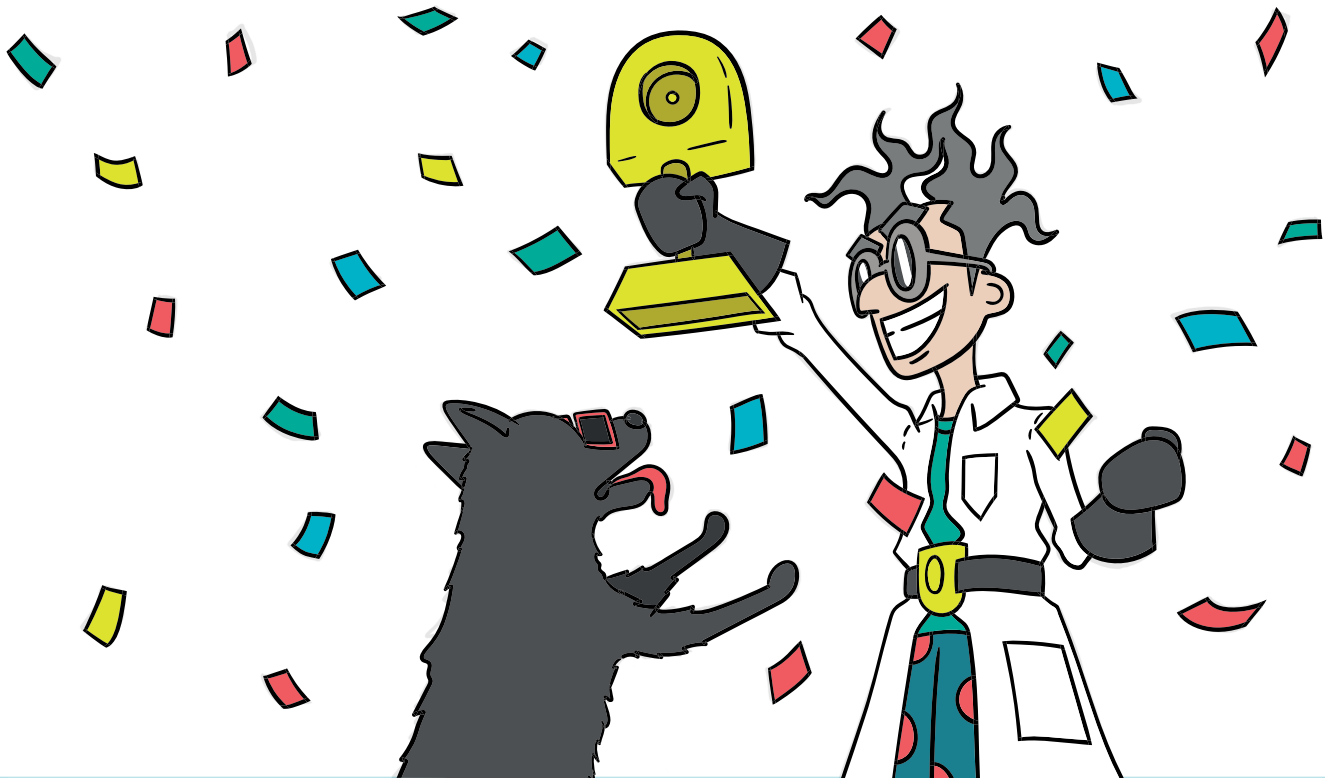

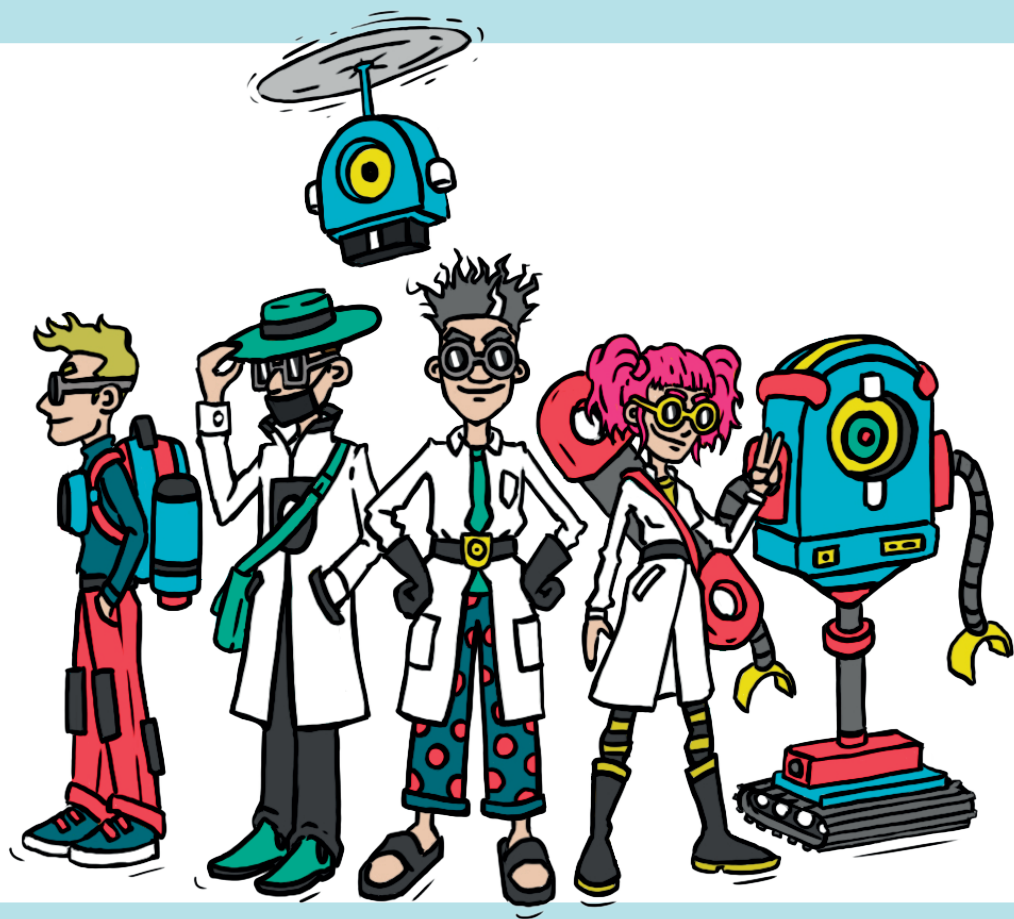

Did you know that Boffin magnetic has two other friends?

Their names are **3Dsimo** and **Noyce Joyce**.

Each of these friends has different super powers. Boffin Magnetic is a young genius. 3Dsimo is a handyman who repairs everything and substitutes an entire workshop. On the other hand, Noyce Joyce can turn any electronics into a kit that is either functional, beautiful or can even be worn.

3Dsimo web: www.3dsimo.com

Noyce Joyce web: www.noycejoyce.com



MORE BOFFIN
ELECTRONIC PARTS ON
BOFFINMAGNETIC.COM

It would not be Boffin Magnetic if he did not prepare a puzzle for you that will help you get a discount on all products from our e-shop.

In every household you have sockets that you use to power your computer, TV, refrigerator and many other appliances. Do not insert metal objects or fingers into these sockets as they have a high voltage. What phase voltage does your socket have at home?

There are multiple correct answers to this puzzle.

Just write the correct answer (number only) in the box in the basket under the name (discount code) in our e-shop and get a 25% discount on any product from our offer.

www.eshop.3dsimo.com



package contains **58 components**

Additional components can be purchased on:
www.boffinmagnetic.com

5x



connection 1

5x



connection 2

5x

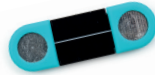

connection 3

4x



connection 4

1x

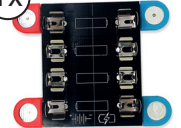

battery 4xAAA

1x

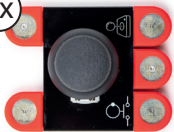

joystick

1x



ON/OFF switch

1x



changeover switch

1x

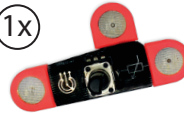

potentiometer
50k Ω

2x



button

1x



microphone

1x



buzzer

1x



speaker

1x

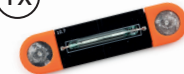

reed switch

1x



OLED display

1x



fotoresistor

1x



lightbulb

1x



white LED diode

1x



green LED diode

1x



red LED diode

1x



resistor 100Ω

2x

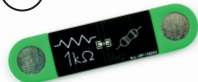

resistor 1kΩ

2x



resistor 10kΩ

2x



resistor 100kΩ

1x



resistor 1MΩ

1x



PNP transistor

2x

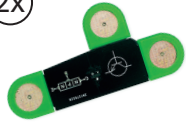

NPN transistor

2x



polarized capacitor 100μF

1x

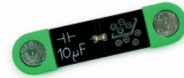

capacitor 10μF

2x



capacitor 100nF

1x



diode

1x

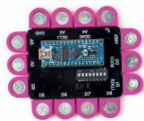

micro computer

2x



cable connection black

2x



cable connection red

1x



magnetic board

